

NASSPA Best Practices Sheet Piling Installation Guide



Contents

1.	General	4
2.	The Soil	5
2.1	Site conditions	
2.2	Soil characteristics	
2.3	Driving characteristics of various soils	
2.4	Choice of sheet piling sections for driving	
3.	Driving Systems	11
3.1	General	
3.2	Diesel hammers	
3.3	Single-acting drop hammers	
3.4	Double-acting hydraulic hammers (hydrohammer)	
3.5	Double-acting air/steam hammers (rapid below)	
3.6	Vibratory piling drivers	
3.7	Sheet piling presses	
3.8	Special driving systems	
4.	Driving Methods	24
4.1	General	
4.2	Set and drive	
4.3	Panel driving	
4.4	Staggered driving	
4.5	Driving of combined walls	
5.	Enclosed Cofferdams	29
5.1	Rectangular	
5.1.1	Panel Driving Method	
5.1.2	Set and Drive Method	
5.2	Circular cofferdams	
6.	Pile Driving Templates	32
6.1	General	
6.2	Upper template	
6.2.1	Driving with fixed leads	
6.2.2	Driving with hanging leads	
6.2.3	Driving with cable-suspended hammers	
6.3	Lower template	
7.	Ancillary Equipment	39
7.1	General	
7.2	Prefabricated trestles and walkway walings (guides)	
7.3	Shackles	
7.4	Threaders	
7.5	Reinforcement points	

7.6	Steel handling tools							
7.7	Driving Caps							
7.7.1	General							
7.7.2	Hammer cushion							
8.	Driving Assistance	45
8.1	Jetting							
8.1.1	General							
8.1.2	Low pressure jetting							
8.1.3	High pressure jetting							
8.2	Blasting							
8.2.1	General							
8.2.2	Normal blasting							
8.2.3	Shock-blasting process							
8.3	Drilling							
9.	Driving Corrections	49
9.1	Corrections of lean							
9.2	Drawing down							
9.3	Control of wall length							
9.4	Driving tolerances							
10.	Special Aspects of Driving	53
10.1	Test-driving							
10.2	Driving in restricted headroom							
10.3	Driving under water							
10.4	Verticle loads							
10.5	Noise levels							
10.6	Ground vibrations caused by pile driving							
10.6.1	General							
10.6.2	Measurement Systems							
10.6.3	Sensitivity of humans to vibrations							
10.6.4	Evaluation of the vibration effect							
10.6.5	Reccomendations to reduce the effect of vibrations							
11.	Flat Web Sheet Piling	62
11.1	General							
11.2	Storing							
11.3	Handling							
11.4	Lifting							
11.5	Driving operation							
11.5.1	Template							
11.5.2	Setting flat web sections							
11.5.3	Driving							
12.	Extracting	69
12.1	General							
12.2	Measures to be taken before and during driving							
12.3	Extraction							

1. General

This manual provides an introduction to the methods of installing sheet piling, based upon the Technical European Sheet Piling Association (TESPA) manual on the installation of steel sheet piling. TESPAs was replaced in the 1990s by European Standards on Steel Sheet Piling.

A knowledge of the characteristics of the steel and piling sections are not enough to guarantee good results prior to installation.

The aim of this document is to briefly describe the practical information that should always be considered in order to ensure proper product installation.

This manual aims to show the importance of predicting the drivability of piling sections following a complete evaluation of all ground conditions.

This is followed by an inventory of the existing driving systems, from impact hammers to vibratory piling drivers and special systems.

The manual then provides a description of driving methods, ancillary equipment (including guide frames) and all necessary procedures to follow when installing sheet pilings.

Finally, some common installation problems are illustrated and several special aspects of driving are briefly outlined.

*Please note that all information in this guide is believed to be accurate but neither NASSPA nor any NASSPA members may be held liable for information which in this guide maybe be found incorrect or misleading. Suggestions made are done so to provide good faith guidance in an effort to help the industry succeed.

2.The Soil

2.1 Site conditions

For the successful driving of sheet pilings, it is essential that a good knowledge of the site conditions be acquired in order to enable an accurate assessment of the topographical and geological conditions.

Topography describes the particular environment of the site, and it details working restrictions such as noise and vibration. Each site is subject to its own unique set of restrictions, which vary according to the proximity and nature of neighboring buildings, road category, underground services, power supplies, material storage areas, etc.

Geological conditions refer to the vertical characteristics of the soil strata.

In order to achieve the required penetration of the sheet pilings, a site investigation of the soils, coupled with various field and laboratory tests, can greatly aid installation by providing relevant information on the following concerns:

- a) stratification of the subsoil;
- b) particle size, shape distribution and uniformity coefficient;
- c) inclusions;
- d) porosity and void ratio;
- e) density;
- f) level of the groundwater table;
- g) water permeability of the soil;
- h) moisture content;
- i) shear parameters and cohesion;
- j) and dynamic and static penetrometer test results, as well as results of standard penetration or pressuremeter tests.

Generally, only the results from section a), e), i), and j) are available.

2.2 Soil characteristics

The following table shows the density in relation to penetrometer and pressuremeter-test results for non-cohesive soils:

DPH ₁	SPT ₂	CPT ₃	Pressuremeter Test		Density
n ₁₀	n ₃₀	q _s	pl	E _m	
		kips/ft ²	kips/ft ²		
	<4	50	<4	30	very loose
3	4 - 10	50 - 160	4 - 10	30 - 100	loose
3 - 15	10 - 30	160 - 315	10 - 30	100 - 300	medium dense
15 - 30	30 - 50	315 - 520	30 - 52	300 - 520	dense
>30	>50	>520	>52	>520	very dense

1. Dynamic probing heavy.
2. Standard penetration test (dynamic).
3. Cone penetration test (static).

The consistency of **cohesive soils** in relation to SPT, CPT and pressuremeter-test results is as follows:

SPT ₁	CPT	Pressuremeter Test		Consistency	Undrained shear strength
n ₃₀	q _s	pl	E _M		
	kips/ft ²	kips/ft ²			lbs/ft ²
<2	5	<3	30	very soft	320
2 - 4	5 - 10	3 - 7	30 - 110	soft	320 - 840
				soft to firm	840 - 1050
4 - 8	10 - 20	7 - 12	110 - 175	firm	1050 - 1570
				firm to stiff	1570 - 2090
8 - 15	20 - 40	12 - 20	175 - 420	stiff	2090 - 3150
15 - 30	40 - 85	20 - 40	420 - 840	very stiff	3150 - 4175
>30	>85	>40	>840	hard	>4175

1. SPT values should not be used to evaluate clay layers.

The correlations between the different methods of soil tests are not based on any standards. Each method gives its own specific classification of subsoil. The tables serve only as an aid to the user to complement their own experience.

2.3 Driving characteristics of various soils

The different types of soil (with the various parameters listed in Section 2.2) present a variety of driving characteristics. A brief description of each is given in this section.

Method: Impact driving

Comparatively problem-free driving may be anticipated in: soft soils such as silts and peats; loosely deposited medium and coarse sands; and gravels free of rock inclusions.

Difficult driving, however, could possibly be expected in: densely deposited fine, medium and coarse sands and gravels; hard clays; and soft-to-medium rock strata. Dry soils will generally give higher penetration resistance than those that are moist, submerged or fully saturated.

Method: Vibratory driving

Round-grain sand or gravel and soft soils are especially suited to vibratory driving. Angular-grain material, or soils with firm consistency, are much less suited.

Also, dry soils give greater penetration resistance than those which are either moist, submerged or fully saturated.

If the granular subsoil is further compacted by the vibrations, then penetration resistance will increase sharply, thereby causing refusal.

For difficult soil layers, it may be necessary to consult the Driving Aids described in Section 8.

2.4 Choice of sheet piling sections for driving

With all civil engineering projects, there is a primary need to minimize the cost of the work. It is therefore important that the most effective pile be selected for the task.

Wide, deep pilings tend to be more cost-effective since they provide the same bending strength (at a lower weight per square foot) as comparable narrow sections.

Their increased width means that fewer pilings are required to cover a given length of wall, so installation costs can therefore be reduced.

The pile section chosen by the designer should be capable of being driven through the various strata to the required penetration depth.

The drivability of a piling section is a function of: its cross-section properties and length; the steel grade used; and, in the case of press-in-hammer systems, the load applied,

the duration of the application and the method employed for installation. The cross-section properties of a pile are based upon: the thickness of the steel; the depth and width of the section; and its designed shape.

The greater the surface area of the piling profile, the greater the driving force required. To avoid unnecessary deformation of the pile head, proper care is needed to ensure that the pile section chosen be compatible with the prevailing soil conditions. The geometry of the pile section may cause plugging of the pilings in most cohesive soil strata and also in certain dense, granular strata.

The driving force required is a function of the soil properties; therefore, it follows that there is a definite limit to the drivability of a given pile profile and the steel grade being used. As the steel grade increases, the stress that the pilings can withstand also increases; thus, logically, the higher-yield steel pilings are more resistant to head or toe deformation than the same section in a lower steel grade.

SPT minimum dominant N_{30} value	Wall modulus (in ³ /ft)	
	low-yield steel	high yield steel
0-10	15	
11-20		15
21-25	20	
26-30		20
31-35	25	
36-40		25
41-45	45	
46-50		45
51-55	55	
56-60		55
61-70	75	
71-80		75
81-140	85	85

Where N represents the Standard Penetration Test value. "Dominant" means the average of the high values for the soils to be penetrated.

Where piles are to be driven only to a toe-hold in rock, the N value shall be divided by a factor of 4 for that stratum only.

Consideration of the soil layers and appropriate parameters will enable expected driving resistance to be assessed and will thus allow for the selection of a suitable section. The following table is based on a simple relationship using Standard Penetration Test results for cohesionless soil strata and a modular pile width of 20in./500mm, using impact hammers.

It should, however, be stressed that the figures given in the table are for guidance purposes only. And it remains essential that an adherence to good driving practice, combined with the use of proper hammers, should be adopted, whenever possible, in favorable conditions.

The table utilizes 23.5in./600mm, which is the average width of the piling sections available; due allowance shall therefore be made for pilings of larger or smaller widths.

The selection of a suitable pile section for driving into cohesive strata is a complex proc-

ess, and the section choice is usually based upon previous experience.

However, it is possible to assess the driving resistance using the surface area of the piling combined with the characteristics of the cohesive strata. This calculation will of course be altered considerably if a plug or partial plug forms across the profile of the toe. In that case, the end that bears the resistance of the plugged profile will have to be included together with a reduction on the surface area of the pile profile. For other driving systems, refer to relevant chapters.





3. Driving Systems

3.1 General

The choice of a suitable driving system is of fundamental importance in order to ensure a safe and successful pile installation.

Various categories of driving systems are detailed below.

3.2 Diesel hammers

A diesel hammer consists principally of a cylinder, a piston (drive) and an impact block at the bottom of the cylinder.

In single-acting hammers, the top end of the cylinder is open; but with double-acting types it is closed. This double-acting effect can also be achieved by using a vacuum chamber.

To start the single-acting hammer, the piston is lifted to a pre-set height and automatically released. The falling piston compresses the air in the compression chamber and activates the fuel pump to spray fuel on top of the impact block. The impact of the piston on the impact block atomizes the diesel fuel, which then ignites in the highly compressed air. This explosive energy throws the piston upwards, thus driving the pile downward and restarting the hammer cycle.

Diesel hammers perform particularly well in cohesive or very dense soil layers. Under typical site conditions, it is normal to select a ratio of drive weight to weight of pile plus cap of a 1:2-1.5:1 ratio. Driving caps, or flat anvil blocks, are necessary to protect the piling heads during driving.

In accordance with the hammer manufacturer's recommendations, a penetration of 10in./25mm per 10 blows should be considered the limit for the use of diesel hammers.

Under certain circumstances, a penetration of .04in./1mm per blow could be allowed for a short period of time. Longer periods of time at this blow rate, however, would cause damage to both the hammer and the equipment.

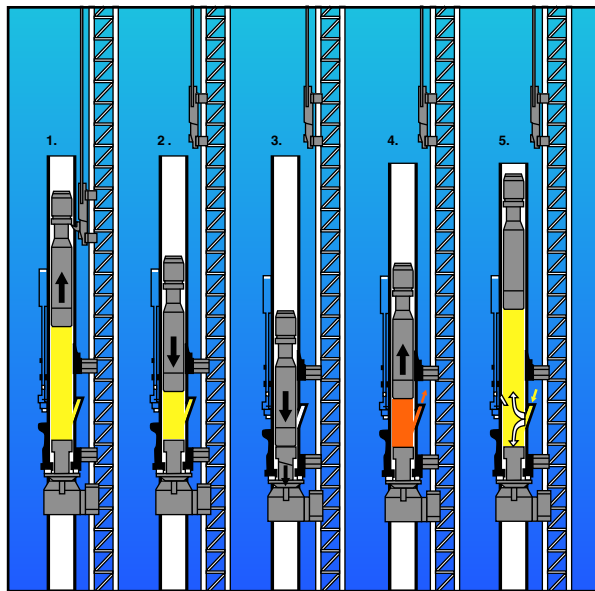

Diesel pile hammers are operating as follows:

1. Raising of piston

For starting the Diesel pile hammer, the ram weight (piston) is raised by means of a tripping device and automatically released at a given height.

2. Injection of Diesel fuel and compression

While dropping, the piston will actuate the pump lever, so that a given quantity of Diesel fuel is sprayed on top of impact block. After passing the exhaust ports, the piston will start compressing the air in the cylinder chamber.

3. Impact and Explosion

The impact of the piston on the impact block will atomize the Diesel fuel in the combustion chamber. The atomized fuel will ignite in the highly compressed air. The resulting explosive energy will force up the piston.

4. Exhaust

While moving upwards, the piston will expose the exhaust ports. Exhaust gases will escape and the pressure in the cylinder will equalize.

5. Scavenging

The piston keeps jumping upwards and will draw fresh air through the exhaust ports for scavenging the cylinder, while also releasing the pump lever. The pump lever returns to its starting position, so that the pump will again be charged with fuel.

Figure 3.2: DIESEL PILE HAMMER

Reprint from DELMAG catalogue.

3.3 Single-acting drop hammers

General

This hammer is easily adapted to drive any of the piling sections for all ground conditions (e.g., above and below the water table), and it also adopts the same drive weight ratio and driving sets as described for diesel hammers.

Drive weights up to 11 tons are available with a variable drop height of up to 4ft./1.2m. At maximum drive weight and stroke height, a blow rate of 40 blows per minute can be obtained when used in automatic sequence.

In order to minimize pile head damage and noise emission levels, it is always preferable to use a heavy drive with a short stroke.

The hammer controls are precise; and when used correctly, this hammer can achieve 75-80% of rated output energy. Data recording units simultaneously store the relevant driving information.

There are three main types of drop hammer:
Cable operated drop hammers

These consist of a machine-lifted weight that is allowed to free fall to drive the pile.
The cable winch can regulate the falling height.

Steam drop hammers

For these special drop hammers, the cylinder represents the falling weight that is lifted by steam pressure.

A valve system interrupts the pressure and causes the cylinder to fall. As needed, the height can be adjusted to the given conditions.

Hydraulic drop hammers

This type of hammer consists of a segmental drive guided by two external supports.
The drive is lifted by hydraulic pressure to a pre-set height and allowed to free fall onto the anvil or driving cap. The weight and the height of the drop of the drive can be varied to suit the piling section and the site conditions.



Figure 3.3-2:
HYDRAULIC
DROP HAMMER

3.4 Double-acting hydraulic hammers (hydrohammer)

This type of hammer consists of an enclosed drive that is lifted by hydraulic pressure. On the downward stroke, additional energy is delivered to the drive, producing an acceleration of 2g. The maximum stroke of 3ft./1m thus corresponds to a free fall drop of 6.5ft./2m.

These hammers range from a maximum energy/blow of 35kNm-3000kNm with a blow rate of 50-60 blows per minute. The electronic control system ensures optimum control of the piling process; and the design enables a range of safety, monitoring and indicating devices which can be incorporated. The net energy applied to the pile, which is measured during every blow and shown on the control panel, can be continuously regulated from a maximum setting to less than 5%.

The hydrohammer can operate at any angles, above and below water level, and is suitable both for driving and extracting pilings. Under normal site conditions, it is standard to select a drive weight that is in the ratio of 1:1-1:2 with the weight of the pile plus the driving cap. In order to minimize pile head damage and noise level emissions, a heavy hammer with a short drop is always preferable.

Up to the present time, only hydrohammers from 35kNm-90kNm energy per blow have been used for sheet piling. Hammers larger in capacity than these are considered to be

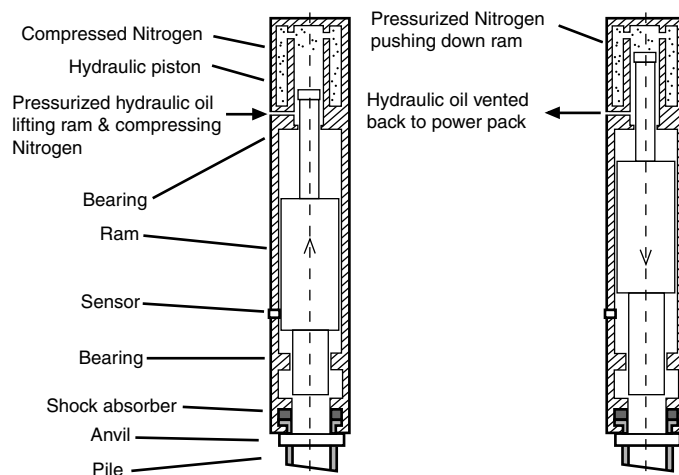

Figure 3.4-1



too heavy.

3.5 Double-acting air/steam hammers (rapid below)

With double-acting hammers, the striking drive (piston) is driven by compressed air or steam when rising and falling.

The air or steam arrives under pressure in a valve box containing a slide valve, which sends it alternately to each side of the piston, while the opposite side is connected to the exhaust ports.

When falling, the striking mass hits a flat anvil fixed to the cylinder resting on top of the sheet pile that is being driven. Then the pressure lifts the piston and allows it to be forced down again onto the anvil.

In comparison with drop hammers of the same overall weight, the drive of the double-acting hammers is much less than that of the drop hammer. It is only 10-20% of the overall hammer weight, but it is effectively increased by the pressure (72.5-116psi/5-8bar) on the upper end of the piston.

The hammers are designed to operate at maximum efficiency when used with standard sizes of the normally available compressors. For such hammers, 90% of the available energy blow is derived from the action of the air or steam upon the piston.

The drive weight of the hammers that are generally used within steel sheet pilings ranges between 220-2866lbs./100-1300kg. The drop height, which generally increases with hammer weight, varies from 4.3-20in./110-500mm. The total striking energy of the largest double-acting hammer is around 30kJ per blow, much less than the biggest single-acting or drop hammers. However, the striking rate of the double-acting hammers is higher, being about 100 blows a minute for the largest machines and 400 blows a minute for the smallest. This striking rate usually leads to continuous movement of the pile, which increases its penetration capacity in soils.

It is not advisable to insert a driving cap between the hammer anvil and the sheet pile being driven, since this will lead to an enormous loss of efficiency.

The double-acting hammers can also be equipped to operate under water and for the extraction of pilings.

For continuous driving, it is standard to limit the driving rate to 6in./150mm per minute; but for short periods of time, a driving rate of up to 2in./50mm per minute may be permitted.

A ratio not less than 1:5 between the drive weight and the weight of the pile is normally chosen.

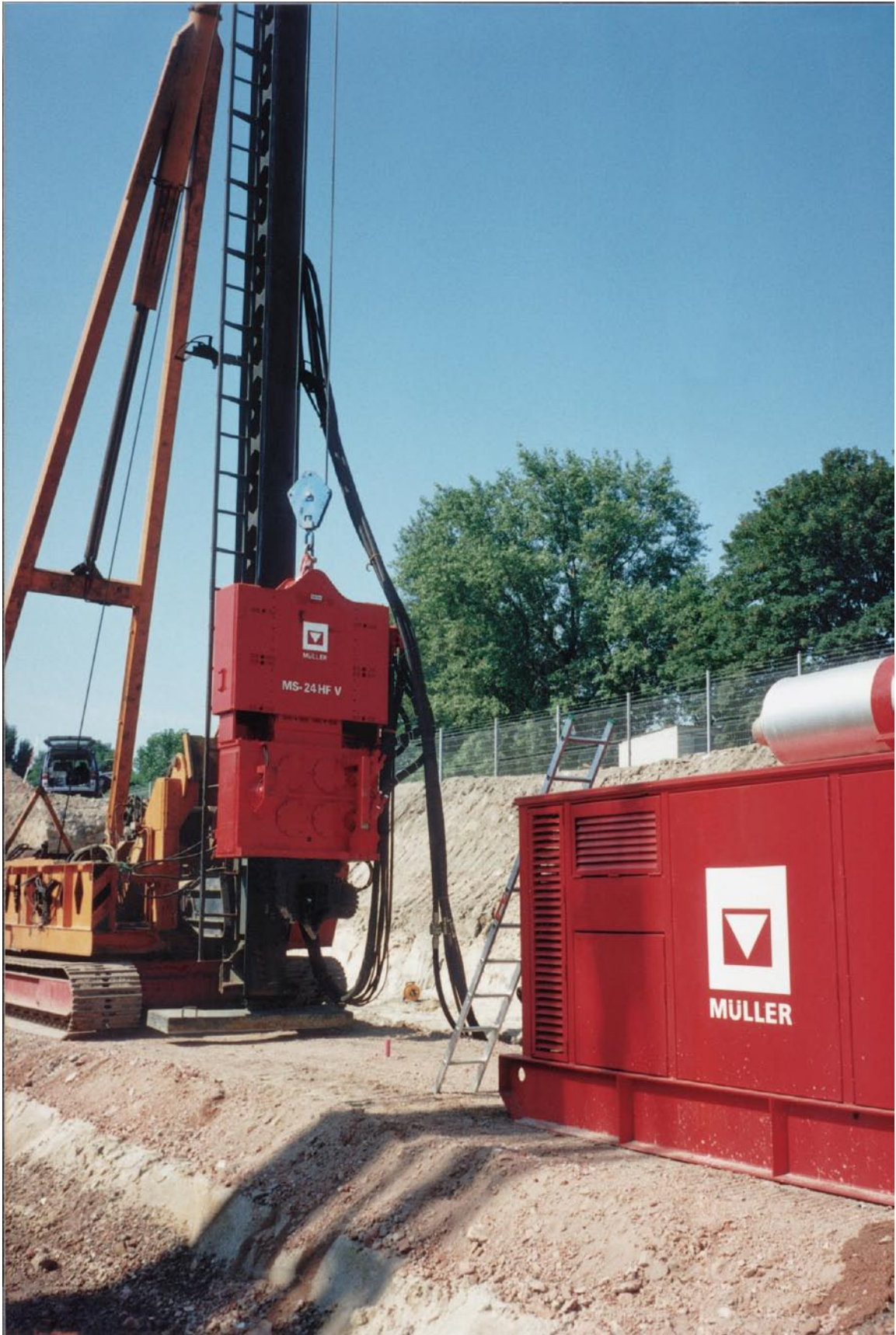

3.6 Vibratory piling drivers

Vibratory piling drivers apply vibrations to the pilings in order to enable them to penetrate certain soil strata.

The principle of vibratory driving is the reduction of friction between the pile and the soil. The vibrations will temporarily disturb the soil around the pile, causing minor liquefaction, which results in a noticeable decrease in resistance between soil and pile. This enables the pile to be driven into the ground with very little added load (i.e., its own weight plus the weight of the driver). The vibratory driver generates oscillations inside a vibration case in which eccentric weights are gear-driven by one or more motors. The weights turn at the same frequency but in the opposite direction, thus eliminating the horizontal components of the forces and leaving only the vertical components operational. The vibratory drivers can be powered by electric or hydraulic motors, or a combination of both.

Hydraulically-operated clamps mounted under the vibration case ensure a secure attachment and transmit the oscillating movements to the pile. The crane suspending the vibratory driver should be isolated from the vibration case by rubber cushions or spring elements. The variable speed features of hydraulic vibratory hammers enable the frequency of the system to be matched to varying soil conditions; and because of the power source, such drivers are perfectly suited for underwater work.

The vibratory pile driver is also a very efficient piling extractor. The decrease in resistance between soil and pile enables extraction to occur with a greatly reduced upward pull, compared with the static extraction force that would be required to extract a similar pile.

The frequency of the standard range of vibratory drivers varies from 800-1800rpm and the centrifugal forces go up to 5000kN. The recently introduced higher frequency drivers give a range up to 3000rpm. The resulting high vibrations attenuate very rapidly, thus causing very few problems to adjacent properties. The penetration performance depends mainly on the soil conditions.

The best-suited soils for vibration work are non-cohesive soil, gravel or sand, especially when they are water-saturated. With mixed or cohesive soils, vibro-drivers can be used where there is a high water content.

Artificially dewatered sands, on the other hand, can be very resistant to vibratory driving.

As a guide to determining the size of a vibratory driver, the following formula may be used:

$$F = \frac{15 \times (t + 2G)}{100} \text{ [kN]}$$

F = centrifugal force,
t = driving depth in m,
G = mass of the pile in kg.

It is generally recognized that a penetration rate of approximately 20in./50cm per minute be used as a limit. This is to be considered only as an indication for the control of pos-

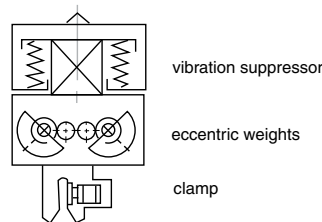
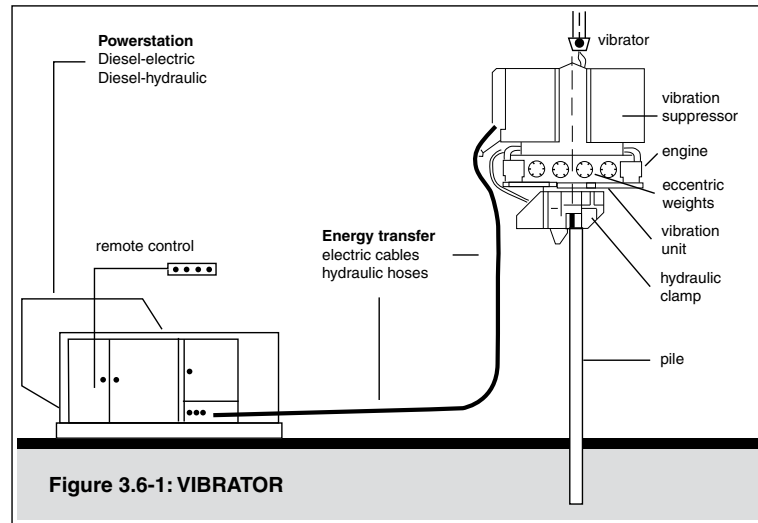

sible vibration nuisance. Careful monitoring is required if driving is continued past the limit.

3.7 Sheet piling presses

The elimination of the noise of sheet pile driving, which had for years been accepted as a nuisance to be tolerated, was the original purpose of the development of sheet piling presses as an alternative to the classical methods.

Originally developed to install pilings silently, the machines are also widely recognized for their vibration-free operation.

The machines (which are especially suited for use in cohesive soils) are hydraulically operated and take most of their reaction force from the friction of the previously driven

pilings. In the standard system, the engine consists of a crosshead containing hydraulic drives and the hydraulic power pack mounted on the crosshead.

Sheet pilings are installed in a panel, and the machine is set on the panel by means of a crane (Type 1).

The hydraulic cylinders are connected to the pilings and, by pressurizing two drives while the others are locked, enable the pilings to be pushed into the ground, two at a time, to the full extent of the drives. When all the drives have been extended, they are retracted simultaneously, causing the crosshead and power pack to be lowered. The cycle is then repeated to completion.

These presses can develop forces of up to 330t/300mt.

Another type of machine with similar features uses a moveable frame to hold the installed panel and to move from panel to panel, giving complete independence from a crane. In this system, pre-drilling loosens the soil during the press operation (Type 2).

A chain pull connected to a fixed point, or to pilings that have already been driven, can provide supplementary press force.

Other kinds of presses jack one pile after another to the complete depth while walking on the previously set pilings. These machines work completely independently from a crane, and they also use the reaction force of the pilings already set to operate. If required, these machines can accommodate limited circular construction (Type 3).

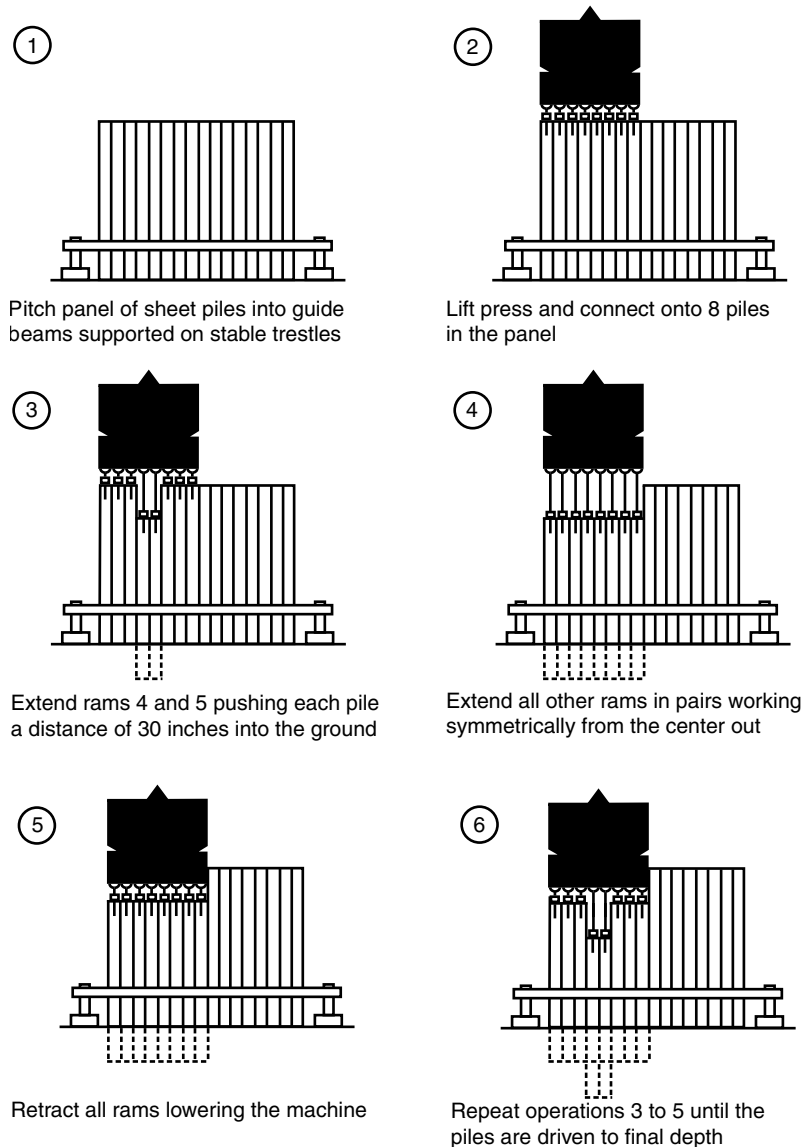

Figure 3.7-1: MACHINE OPERATION (Type 1)



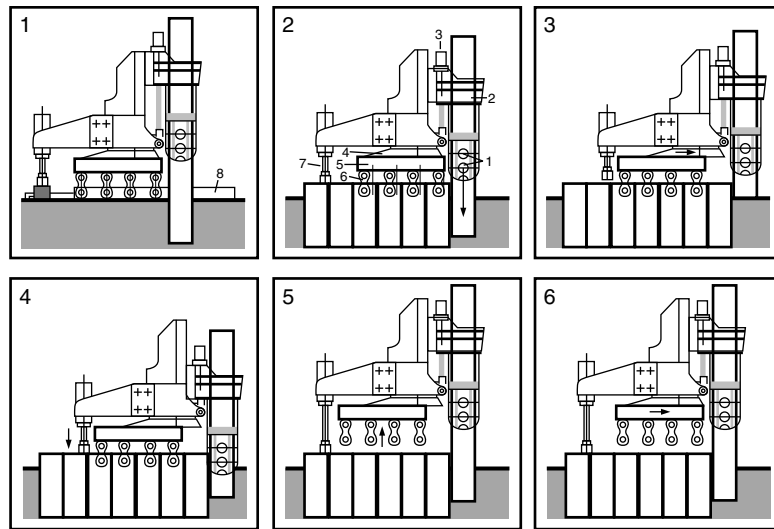

Figure 3.7-4: MACHINE OPERATION (Type 3) SINGLE PILE PRESS
Reprint from MULLER catalog.

1. Setting of press and reaction table (8). For the first pile supplementary weight can be up on to the machine.
2. In normal working, reaction force is taken from the already pressed piles.
3. Support (7) is lifted and press head moves forward.
4. New pile is pressed to give support.
5. Engine, sitting on pile and support (7), lifts the clamp unit (5).
6. Clamp unit moves forward to fix to installed piles again.

3.8 Special driving systems

Besides the common driving systems, there are many special types designed for particular jobs or applications. These include:

- a) Impact hammers incorporating a special cushion system formed out of steel springs or inert gas that transmit the driving energy to the pile more smoothly and over a longer period of time.
- b) A driving system that vibrates and presses on sheet pilings simultaneously.
- c) An impulse hammer operated hydraulically but with an extremely rapid sequence of strokes.
- d) A driving system that impacts and vibrates the sheet pilings simultaneously.

It may be of benefit to use jetting or pre-drilling in conjunction with any of the above driving systems.

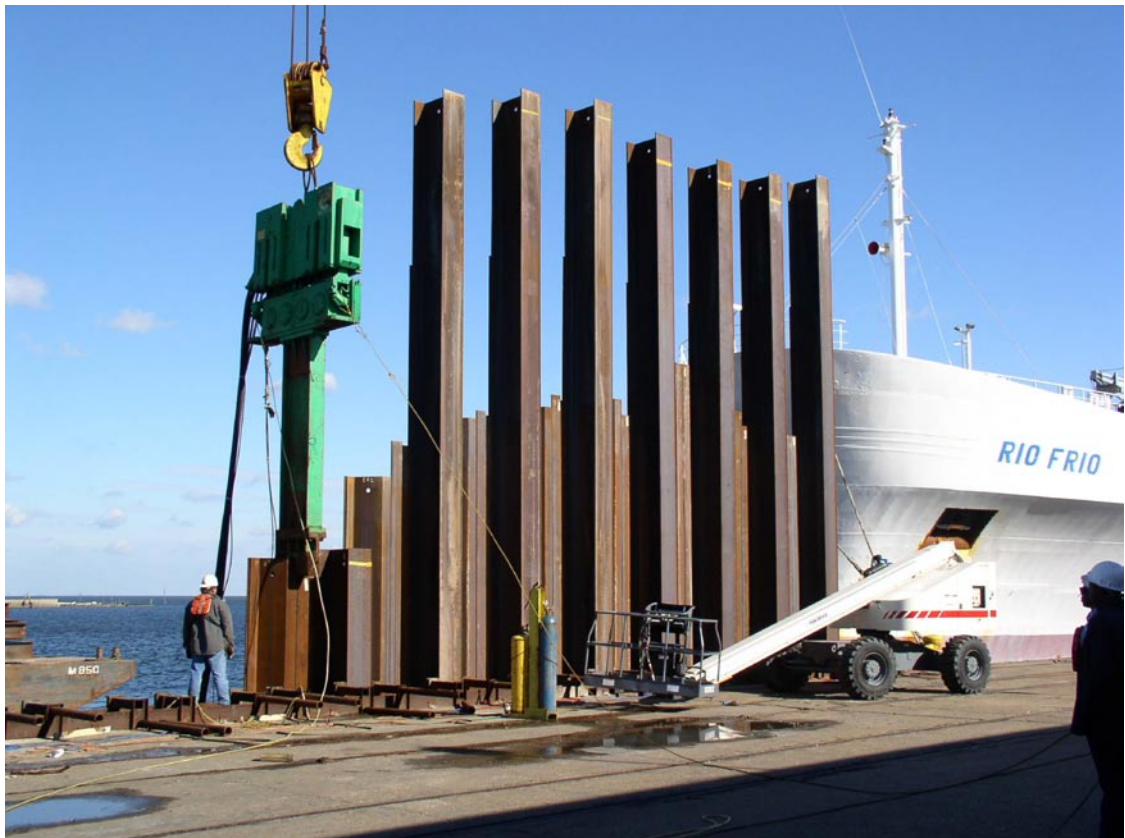
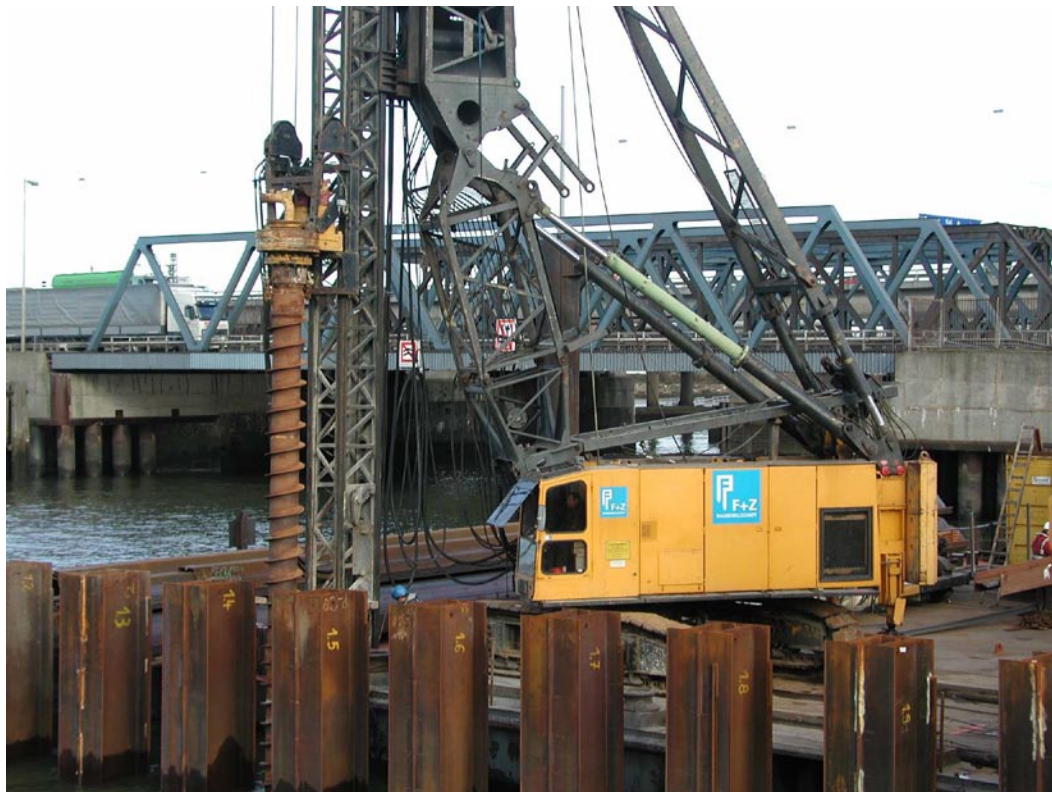

4. Driving Methods

4.1 General

While it is recognized that, in common with most civil engineering projects, a measure of flexibility is desirable to meet site conditions, every precaution must be taken to maintain the necessary standards of safety while, at the same time, setting the required alignment and verticality of the installed pilings.

The first sheet pile should be installed with great care and attention to ensure that it is vertical in both planes of the wall.

Before being released and having the hammer applied, it is essential that the subsequent pilings be interlocked sufficiently with the preceding pile. This can be achieved by a preliminary dug-out trench in the wall line, which automatically reduces the driving length.

4.2 Set and drive

This method, where each sheet pile is driven to full depth before setting the next one, is the simplest way of driving; but it can be utilized only in loose soils and with short pil-

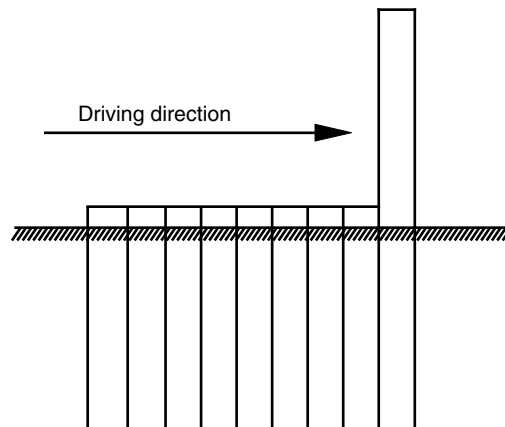

Figure 4.2: PITCH AND DRIVE

ings. The free-leading interlock is constantly in danger of deviation. For dense sands and stiff cohesive soils – or in the case of possible obstructions – panel driving is recommended instead.

4.3 Panel driving

Sheet piling should be installed using the panel-driving technique in order both to ensure that good verticality and alignment is achieved and to minimize the risk of installation difficulties or driving out of interlock.

This technique also enables complete control to be maintained over the nominal wall length.

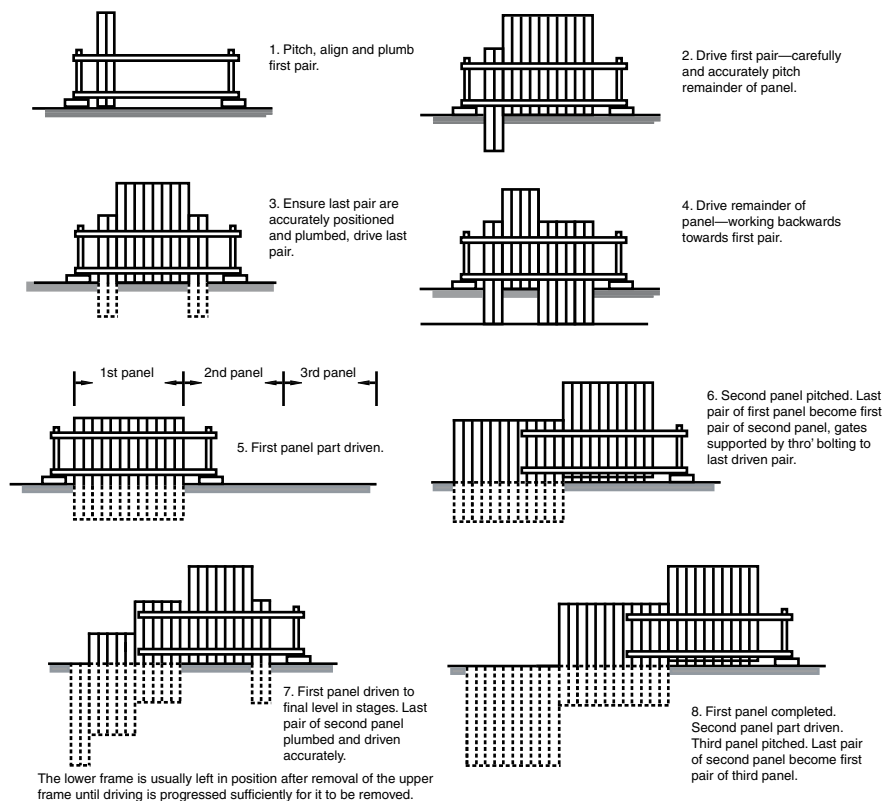

Figure 4.3: PANEL DRIVING

Because a whole panel of pilings has been set, there is no need to drive all pilings fully to maintain piling operations. If obstructions are encountered, individual pilings can be left high without fear of disruption to the progress of setting the wall.

4.4 Staggered driving

In difficult soil conditions, panel installation combined with staggered driving is recommended.

The pilings are installed between guide frames and then driven in short steps, as follows: pilings 1, 3 and 5 first; then pilings 2 and 4.

If the soil is very dense sand, gravel or rock, pilings 1, 3 and 5 can be reinforced at the toe. In this case, these pilings are always driven first; and pilings 2 and 4 are driven in

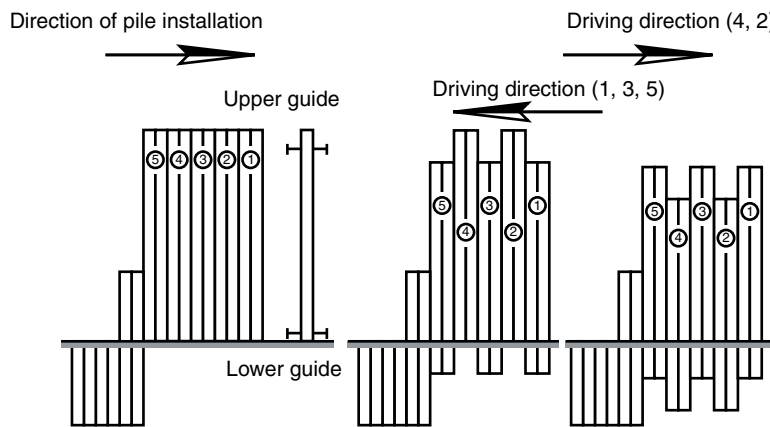

Only the reinforced elements 1, 3, 5 are pre-driven; the other 2, 4 . . . follow.

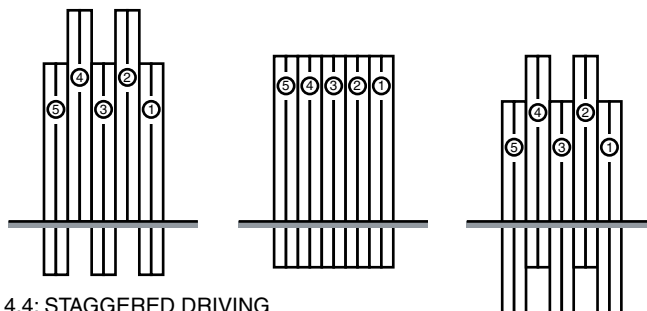

Figure 4.4: STAGGERED DRIVING

the second stage.

4.5 Driving of combined walls

Combined walls are piling walls that comprise high modulus structural components interspaced by lighter sheet pilings. The high modulus components – known as king pilings – can be tubular, box, bearing or other types of fabricated pilings.

It is essential that a stable, heavy, adequately rigid and straight pile-driving template frame, adapted to suit the length and weight of the pilings, be provided.

The king pilings are fixed into position within the template using welded bracket guides which take into account width tolerances.

Driving of the king pilings must be carried out with extreme care in order to ensure that they are embedded straight and vertical, or at a prescribed batter, thereby guaranteeing that they are parallel to each other and at the required spacing.

The driving sequence of the king pilings must ensure that the pile toe encounters have impacted soil uniformity on its total circumference and not just on one side only.

This is achieved by driving in the following sequence:

1 – 5 – 3 – 6 – 4 – 7 – 2 (large driving step).

At the least, however, the following sequence should be observed:

1 – 3 – 2 – 5 – 4 – 7 – 6 (small driving step).

In general, all of the king pilings should be driven in sequence to full penetration without interruption. Following successful completion of this, the intermediate light piling sections can be set and driven. During the setting and driving operations of the king pilings, a constant check (using theodolites) should be made of their alignment in relation to the wall.

When the guide frames have been removed, a final survey should be made to ensure that the deviations in the distance between the king pilings are within the acceptable tolerances in order to allow the proper installation of the sheet pilings. However, if the deviations are outside the specified or practical tolerances, then either the intermediate pilings have to be adjusted or the king pilings must be extracted and re-driven.

To overcome difficult driving conditions, it may be possible to use: jetting; excavating inside the king pilings; or any of the ground pre-treatment methods normally adopted for sheet piling.



5. Enclosed Cofferdams

5.1 Rectangular

5.1.1 Panel Driving Method

Before driving commences adjacent to a corner pile, the craneage available should have sufficient reach to enable each pile to be interlocked into the previously set pile.

Working around the perimeter, the final and closing panel – which should include a corner pile – must be set and interlocked with the partly driven first pair of pilings before driving has been started. This is to ensure satisfactory closure of the cofferdam.

In small cofferdams, it is advantageous to set all pilings before the start of driving, since this will alleviate possible difficulties in closing the cofferdam.

5.1.2 Set and Drive Method

Driving should start and stop at 5 double pilings from the final corner. Closure of the cofferdam is achieved by adjusting the alignment of the wall either inwards or outwards to suit the dimensions of the pilings being used.

It is important that verticality of the pilings be maintained during driving of the plain and corner pilings; if necessary, any tendency to lean should be corrected by using taper pilings.

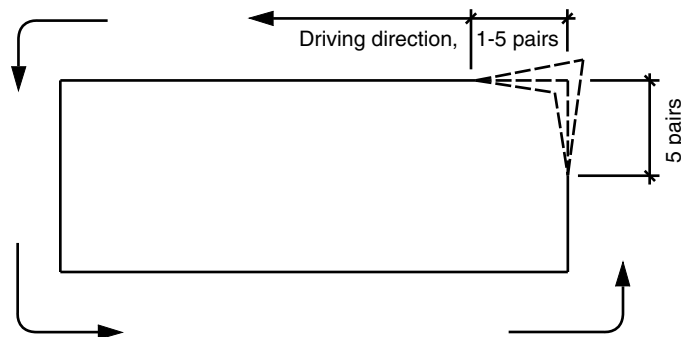

Figure 5.1.2

If the cofferdam dimensions have to be strictly adhered to, then special fabricated pilings will probably have to be provided.

5.2 Circular cofferdams

The length of the pile, its straightness and the soil pressed into the interlock during driving have a considerable influence on the achievable deviation of one pile from another. These deviations considerably increase the friction in the interlocks. For small cofferdams, it is prudent, where possible, to set and interlock all the pilings around a driving template before starting to drive. Driving should progress in stages using a short leading increment of one pile to the adjoining pile.

In large cofferdams, strict control on verticality must be maintained, preferably using panel-driving techniques to facilitate closure of the cofferdam. It may also be necessary to re-arrange the final panel by increasing or reducing the radius of the cofferdam slightly, or by introducing a specially fabricated pile.

Cofferdams of small diameters may not be achievable with interlock rotation alone, and therefore may require the introduction of pre-bent pilings or fabricated special pilings.

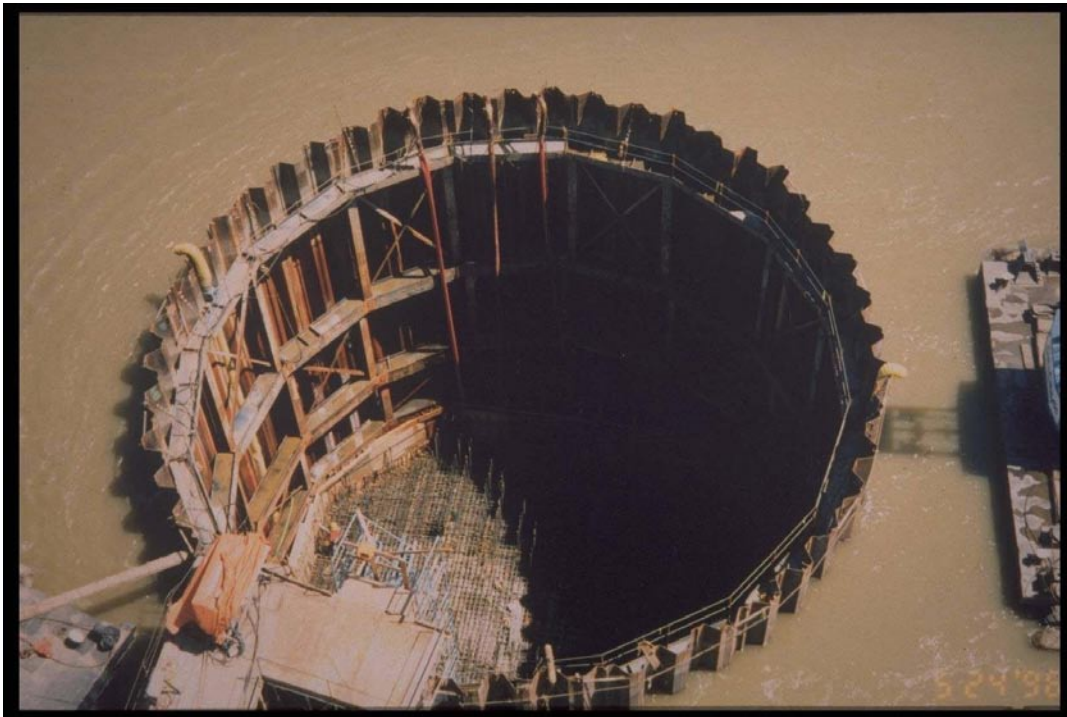



6.Pile Driving Templates

6.1 General

It is particularly important that sheet pilings be maintained in the correct horizontal and vertical alignment during installation. This is achieved by the use of adequate steel templates, which will also prevent lateral drift.

Each element to be driven should be guided in at least two levels (Fig. 6-1). The accu-

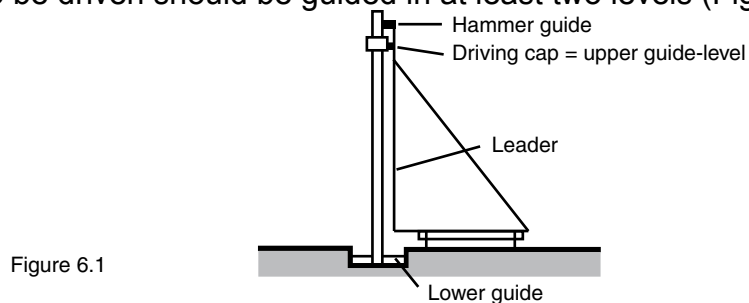

racy and effectiveness of the guides will be improved by maximizing the distance between the two levels. Very long sheet pilings may need intermediate guides to prevent flexing and other associated driving problems.

6.2 Upper template

6.2.1 Driving with fixed leads

With this method, both the hammer and the pile are guided by the leads. It is therefore

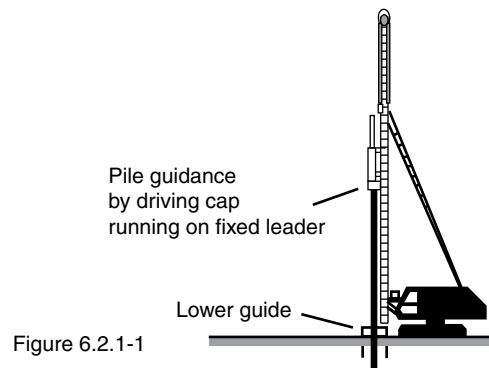



important that the fixed lead is always vertical and that the hammer impacts its energy down the centroid of the pile profile.

6.2.2 Driving with hanging leads

This system employs a hammer that is supported and guided on the pile head by a cable-suspended lead, using a driving cap or leg guides. To ensure correct alignment of the hammer and firm seating on the pile head, the leg guides must be of adequate length and fit to ensure minimal movement

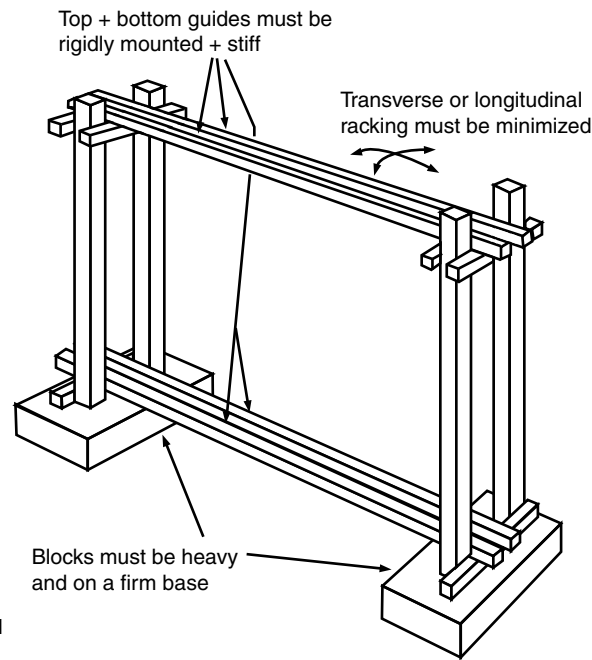

Figure 6.2.3-1

6.2.3 Driving with cable-suspended hammers

Hammers may be used cable-suspended with leg guides fitted to suit the profile of the sheet pile. A robust frame can be used to provide upper level guidance for the pilings. To be effective, it should be at least a third of the pile length above the lower guide and, preferably, located as close to the top of the set pilings as possible.



6.3 Lower template

Irrespective of the driving method, a template is always required at a low level to ensure correct alignment of the steel pile wall. It should consist of two sturdy beams and be mounted as low as possible, preferably on the ground. Lateral movement of this template must be prevented. The template length should cover at least 6 pile pairs, the existing wall (previously driven) being covered along some 5ft./1.5m additional to the 6 pairs. Spacers must maintain the proper spacing of the beams.

When setting and driving, a guide element consisting of a spreader and bracket should be located adjacent to the sheet pilings being driven in order to prevent frame bulging.

To prevent pile twist within the frame, the free flange of a Z-type sheet pile, or the free leg of a U-type, should be secured by a guide block during driving.

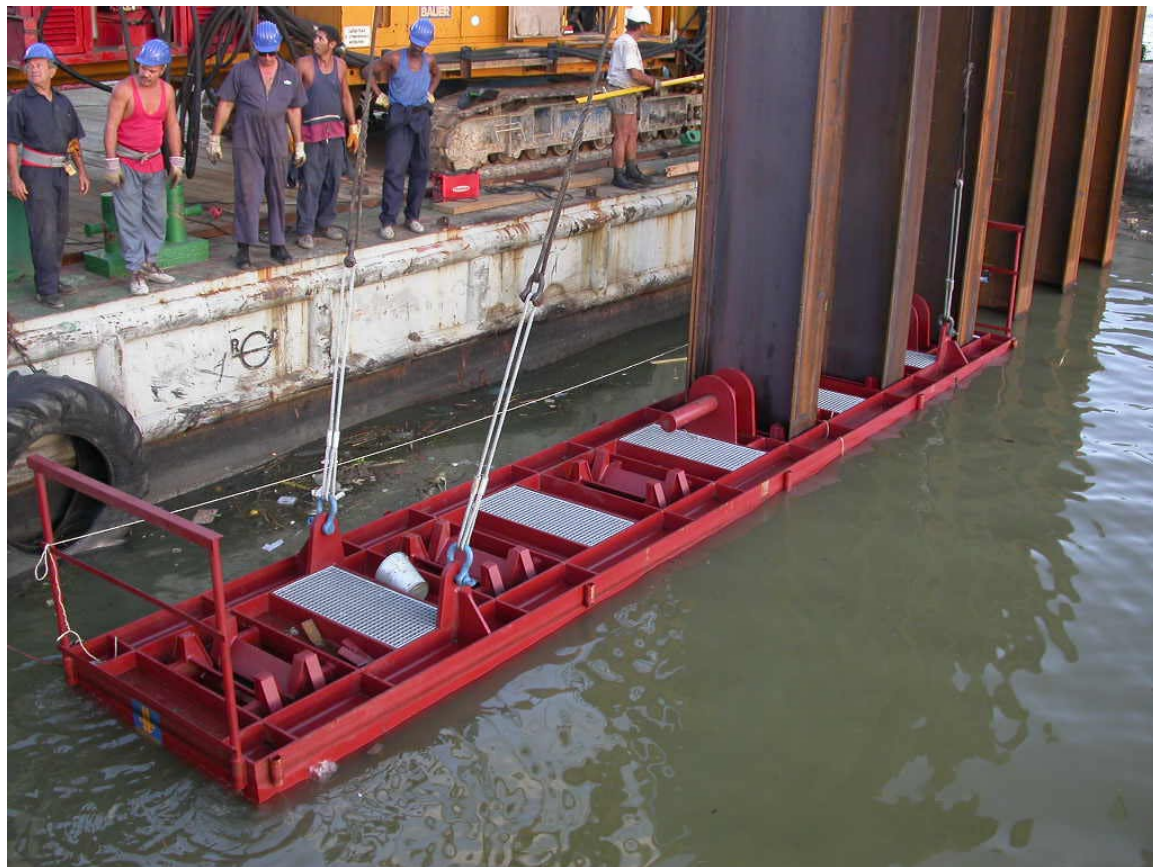



When pile driving in water, the lower frame can be attached (above or below water) to temporary bearing pilings.

7.3 Shackles

Besides the standard shackles widely used, a variety of ground-release and ratchet-release shackles are also available. These enable the crane connection to the pile top to be released, when required, from either ground level or walkway waling level. This



Figure 6.3-3



Figure 6.3-4

is fast, efficient and safe. The shackle uses a lifting hole in the head of the pile through



7.Ancillary Equipment

7.1 General

To better facilitate the handling, setting and driving of the piling process, the following aids should be considered.

7.2 Prefabricated trestles and walkway walings (guides)

Trestles are quick to erect, strip and move, and they can be dismantled and neatly stacked for transportation. Safety features are incorporated to provide safe access and working space when assembly is either complete or partially complete.

Walkway walings provide both safe access and working space. They are stiff box-girder beams that provide a rigid guide and straight edge for accurate pile alignment.



Figure 7.2

Reprint from DAWSON catalogue

which a shear pin passes. Friction grip methods of lifting should never be used, as they can accidentally release in a number of ways.

Method of operation for shackles when used in conjunction with pile threader (see Threaders, section 7.4)

1. Retract main pin on shackle until locked in open position. Slide shackle over pile head. Pull looped wire to release pin, ensuring it is fully located through hole in pile and into shackle body.

Attach a length of soft rope to pin-release wire.

2. Hoist pile into position and attach pile threader.

3. Locate pile threader and tie pin-release rope on shackle to threader (to prevent trap-

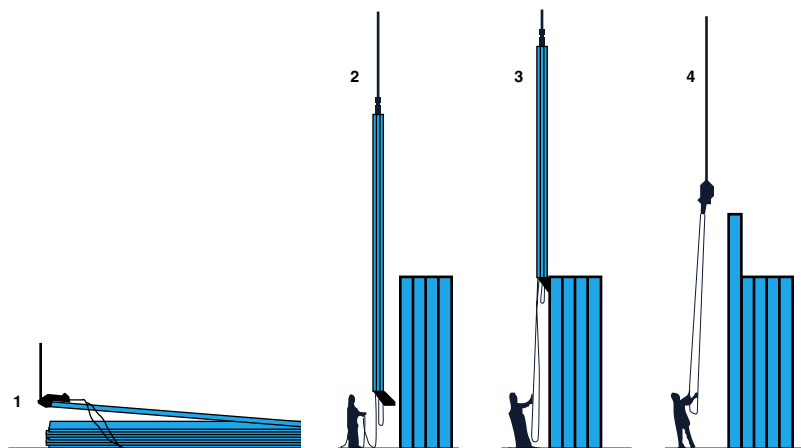
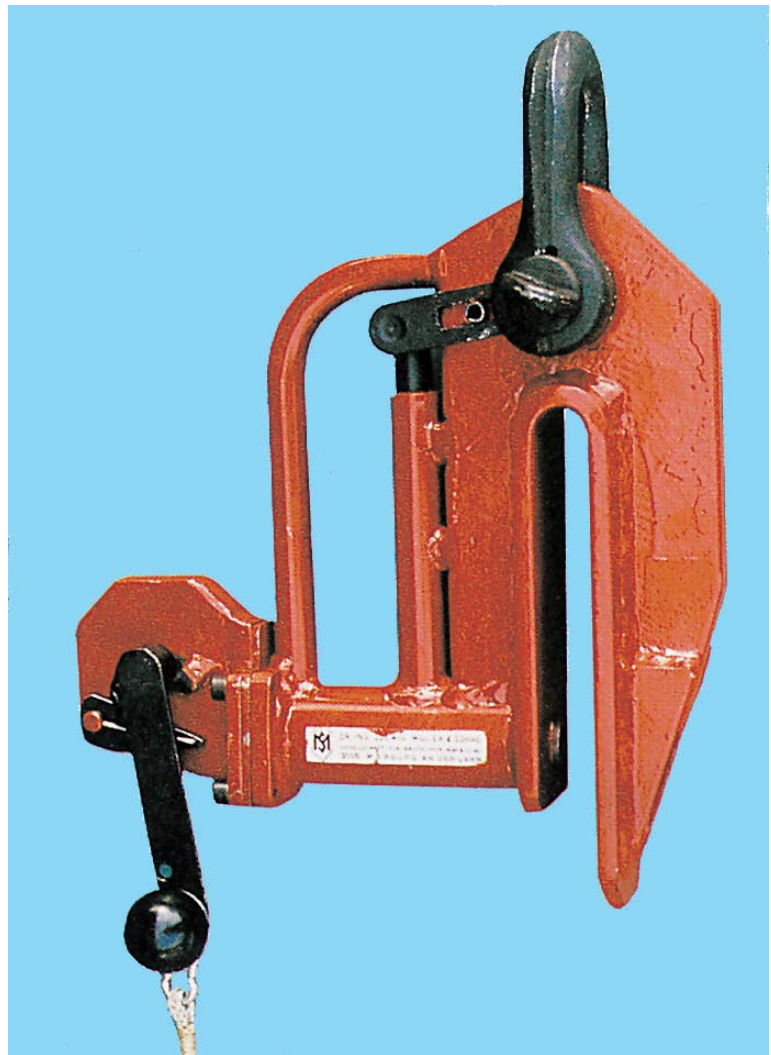

Figure 7.3-2

Reprint from DAWSON catalogue.

ping or sagging). The sheet pile is then pulled up into threading position.

4. After threading has been completed, release shackle by pulling pin-release rope.

7.4 Threaders

As a consequence of panel driving, there is a need to interlock pilings and release their crane connection, at a high level, with both efficiency and safety. The sheet pile threader is designed to interlock any steel sheet pile, thereby accommodating the different profiles, handling and interlock types without requiring a worker be positioned at the pile top. Work on setting pilings can also continue in windy conditions that would stop manual interlocking, making the work more efficient as well as safer.

7.5 Reinforcement points

Having taken all necessary precautions to guide the pilings accurately during installation, pile design efficiency may still make the pile vulnerable to damage from artificial or natural obstructions such as cobbles, boulders, concrete and old timber pilings.

Reinforced points can be provided to give strength to the leading edge of the sheet pile and to help maintain its shape when passing through difficult ground.

7.6 Steel handling tools

These are simple cast-steel shoes designed to slide between each pile in a stack to enable easy separation and handling.

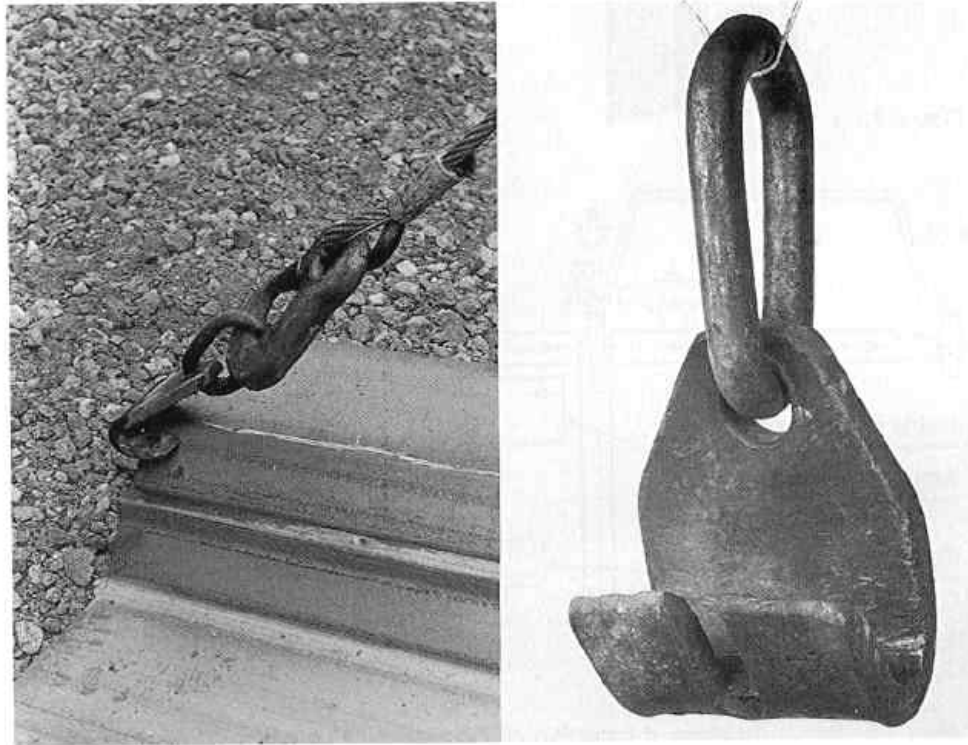

Figure 7.6-1

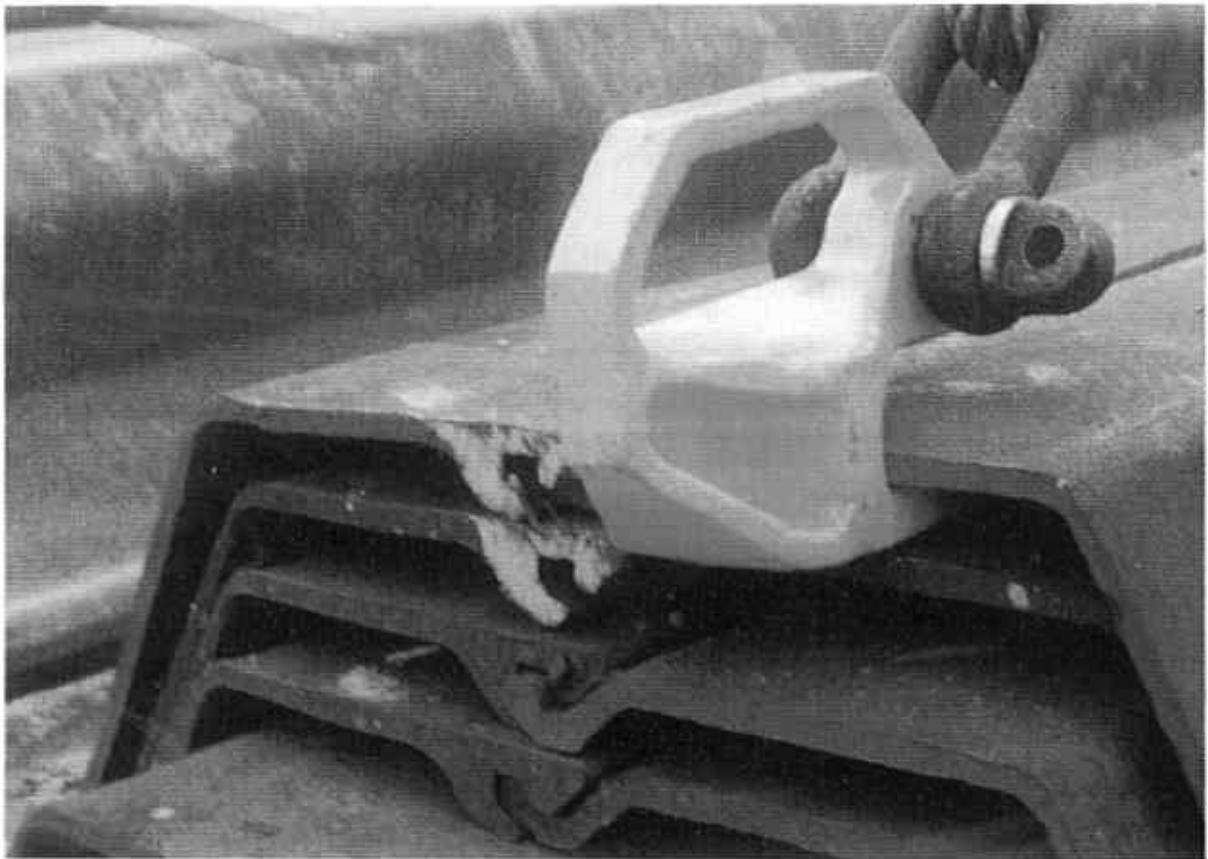

Figure 7.6-2

Reprint from DAWSON catalogue

7.7 Driving caps

7.7.1 General

When using impact hammers, in order to transmit the blow directly to the pile – and also to protect the hammers and the piling heads – the use of driving caps with a dolly may be required.

Guiding grooves for the pile are formed on the lower surface of the driving cap.

A spacer insert to give the required clearance can obtain a suitable connection between the leader and the driving cap.

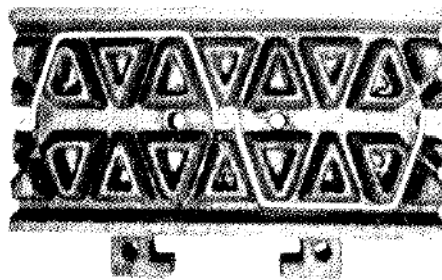

Figure 7.7.1-1

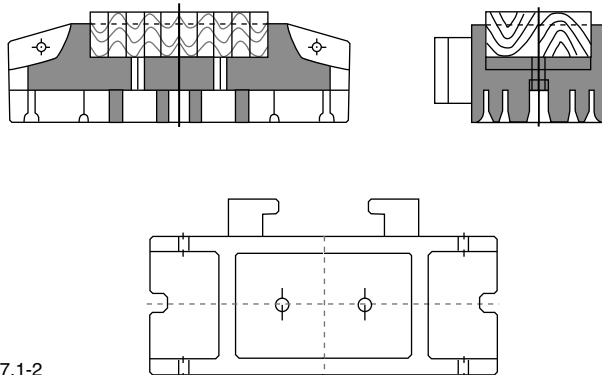

Figure 7.7.1-2



The insert must have a sliding connection both on the cap and on the leader.

7.7.2

The cushion is fitted into a recess on the upper surface of the driving cap. It partially absorbs the blow from the hammer and thus prevents damage to both the hammer and the cap.

Cushions are normally built of plastic or wooden components, with a combination of steel cables and steel plates that ensure a reasonable life expectancy and also helps to quickly dissipate the generated heat. When hard driving is experienced, the cushion has to be replaced more frequently than under normal requirements.

8. Driving Assistance

8.1 Jetting

8.1.1 General

Under certain conditions, driving, vibrating and pressing of pilings can be optimized with the help of jetting. This also prevents overloading of the installation machine or damage to the pilings; furthermore, it reduces ground vibrations.

The objective of this procedure is to locate a pressurized water jet at the toe of the pile that is connected by a pipe to a supply pump on the ground surface.

The water pressure loosens the soil and removes loose material. The toe resistance of the pile is reduced and, depending on the soil conditions, the rising water reduces surface and interlock friction.

The density of the soil, the available water pressure and the number of jetting pipes influences the effectiveness of the jetting. Care must be exercised to ensure that the ground treatment does not endanger adjacent structures.

Test driving to define the parameters is recommended.

8.1.2 Low pressure jetting

Low pressure jetting is mainly used in dense, non-cohesive soils.

In combination with a vibratory pile driver, jetting can enable pilings to penetrate very dense soils. Vibratory hammers with variable eccentricity have proven to be particularly successful.

Two to four tubes of 0.8in./20mm diameter are fixed to a pair of sheet pilings. A pump, giving a pressure of 290psi/20bar, serves each tube. Water volume per tube should be 32-63gal/120-240l per minute. The toes of the tubes are at the same level as the toe of the pile, and jetting starts simultaneously with the driving to prevent intrusion of soil into the tube.

In general the soil characteristics are only slightly modified, although special care must



be taken when pilings have to carry vertical loads.

8.1.3 High-pressure jetting

High-pressure jetting may be used for driving in extremely dense soil layers.

If there is a risk of settlement, high-pressure jetting is preferred to low pressure due to the reduced amount of water being used.

High-quality tubes are required, with the pump pressure being 3625-7250psi/250-500bar.

Special nozzles (e.g., flat jet nozzles, occasionally) are used (1in./30mm diameter for the tubes, .06 or .12in/1.5 or 3.0mm diameter for the nozzles). Water consumption is 16-32gal/60-120l per minute, per tube. Soil mechanical characteristics are not modified by the system: test driving in chalk, boulder clay and hard clay has proven this.

The tubes, fixed at the pile top, are guided in side brackets welded to the pilings so that they can be re-used. The nozzles are located .2-.4in./5-10mm above the pile tip.

Intensive monitoring is required during the work to adapt the system to the local conditions.

The diameter of the nozzles has to be adapted to the ground conditions, as have the number and arrangement of the lances.

8.2 Blasting

8.2.1 General

This process is applicable to most types of soil that, until now, would have been classified as difficult or impossible for driving steel sheet pilings, H-section, box and tubularpilings.

8.2.2 Normal blasting

Explosives are lowered into drilled holes and covered with soil before detonation. This creates a V-shaped trench along the proposed line of the wall. The size of the fragments in the trench is dependent upon the amount of explosives used.

The driving conditions in the loosened area are still very tough; therefore, toe reinforcement of the pilings is recommended.

8.2.3 Shock-blasting process

This blasting technique is a highly specialized form using very low-powered explosives, the principle being to reduce solid rock to a fine granular material without either displacing it or blasting a cavity into the rock.

The volume of rock affected is very small, being just sufficient to encompass the dimensions of steel pilings.

The width of the granulated rock zone would be 20-27.5in./500-700mm and to the exact depth of the required pile penetration. The rock immediately adjacent to this zone remains totally intact.

To obtain maximum benefit from the process, the sheet pilings should be driven in this granulated zone as soon as possible after blasting.

Driving the sheet pilings into this zone compacts the soil, thus ensuring adequate support for the embedded pilings.

8.3 Drilling

Easier impact driving, vibrating and pressing can be achieved by pre-drilling. Holes of about 12in./30cm diameter are drilled at centers of the system width of a pair of pilings. This spacing is reduced for more difficult driving conditions.

The holes have the effect of reducing the resistance of the soil strata by allowing distribution during subsequent driving of the pilings. If greater diameters of holes are required, they must be filled with suitable material.

Even soils such as hard rock layers can be made suitable for driving this method.

Sometimes the loosening of the soil by an auger may be sufficient. Another possibility is the creation of a trench by a power auger. This trench can then be filled with suitable material; or, it may just consist of loosened soil.

9. Driving Corrections

9.1 Correction of lean

In order to avoid the tendency of sheet piling to lean, the hammer should be positioned over the center of gravity of the pilings being driven and should be held vertically and firmly on the pilings by means of efficient grips.

Transverse leaning of sheet pilings is eliminated by the use of efficient guide walings. If the pilings develop a transverse lean which needs to be corrected, the pilings should be extracted and re-driven using more efficient methods.

Longitudinal leaning in the direction of driving which can neither be caused by friction between the last previously driven pile and the pile being driven, or by incorrect use of the hammer – should be counteracted as soon as it becomes apparent; otherwise, the condition could become uncontrollable.

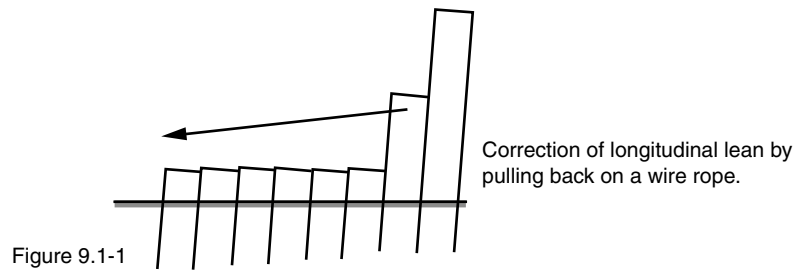

In conjunction with the above method, the hammer can be placed off-center of the pair of pilings towards the last driven pilings.

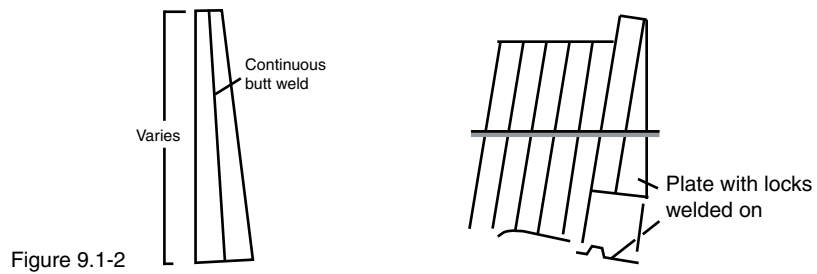

When, in spite of all precautions, a lean cannot be eliminated, taper pilings must be employed to correct the error.

9.2 Drawing down

When pilings are driven in soft ground – particularly when they are allowed to lean – the pile being driven may draw down the adjacent pile below its intended final level. If this occurs, the welding on a short length should extend the affected pile.

In order to prevent the drawing down of previously driven pilings, several pilings may be bolted together with a waling; or alternatively, the interlocks may be tack welded. As a further precaution against drawing down, a bolt may be inserted into the leading interlock of the pile prior to driving, thus both preventing the soil from entering the interlocks and also reducing friction in the driving of the next pile.

Alternatively, a clamping device for the sheet pile locks may be used, thereby avoiding two or more sheet pilings from being drawn (or extracted) at the same time. If one is not sufficient, a supplementary clamp can be used on the next lock.

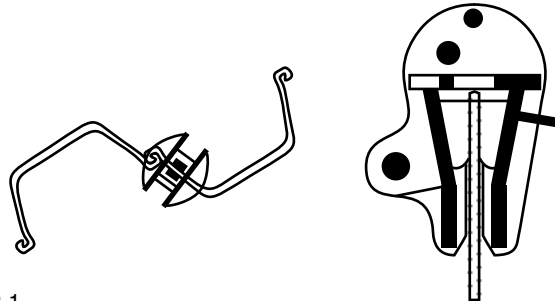

Figure 9.2-1



Figure 9.2-2



9.3 Control of wall length

Some control over the theoretical lock centers, which govern the length of the wall, can be established during setting by varying the overall depth of the pile section.

U-sections: If the wall is found to be gaining in length, this gain may be corrected by reducing the width between guide beams with timber blocks placed between the outside faces of the pilings and the guide waling.

Z-sections: If the wall is found to be gaining in length, this gain may be corrected by increasing the guide width with timber blocks placed between the inside faces of the pilings and the opposite guide walings. Conversely, a loss in length can be corrected by decreasing this guide width.

If accurate theoretical wall dimensions have to be achieved, it may be necessary to introduce a fabricated pile.

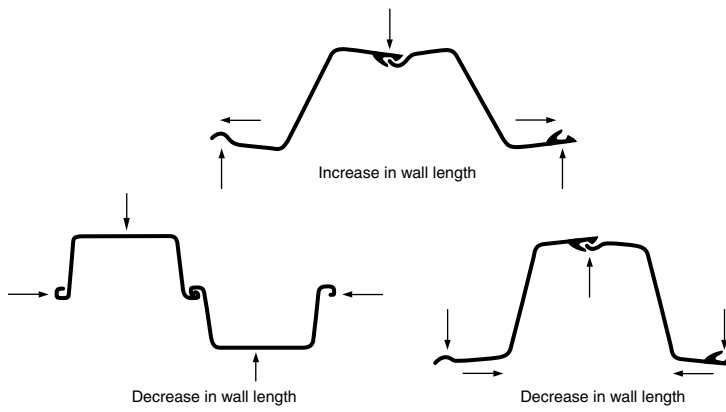

Figure 9.3

9.4 Driving tolerances

Position and orientation of the sheet pilings are indicated in the driving plan. Deviations from this theoretical layout may occur due to rolling tolerances, soil conditions, setting and driving procedures.

General tolerances for a straight and plumb sheet pile wall should be in accordance with the following figures:

- | | |
|---|-------------|
| a) deviation normal to the wall line at the top of the pile | ± 2in./50mm |
| b) finished level deviation from nominal level of top of pile | ± .8in/20mm |

toe of pile		± 4.7in./120mm
c) deviation of verticality	for set and drive method	for panel drive method
normal to line of pilings as per cent of driving depth	± 1%	± 1%
d) deviation of verticality along line of pilings as a per cent of driving depth	± 1%	± 0.5%

In some cases – and for certain circumstances – tighter tolerances may be specified, as in the case of king pilings of combined walls, where accuracy is especially important.

10. Special Aspects of Driving

10.1 Test-driving

When an evaluation of the drivability of the soil is difficult to assess, test driving is recommended.

The reason for test-driving is to determine an adequate pile section which, when driven by a suitable hammer, will reach the required depth.

Test drives should be done in the line of the final wall, their number depending on the size of the project and on the variations of the subsoil strata.

Good control of the pile and the hammer is required, and driving records must be taken.

Subsequent extraction of the pilings may give supplementary information.

10.2 Driving in restricted headroom

Under bridges, etc., the free height between soil level and the structure is often insufficient to allow normal pile threading/setting.

One possibility is to drive the pilings in short lengths, butt-welded or splice-plated to-

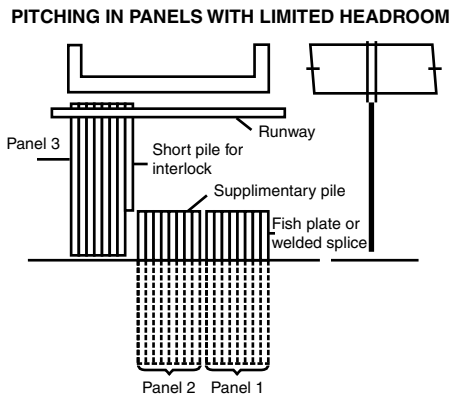

Figure 10.2-1

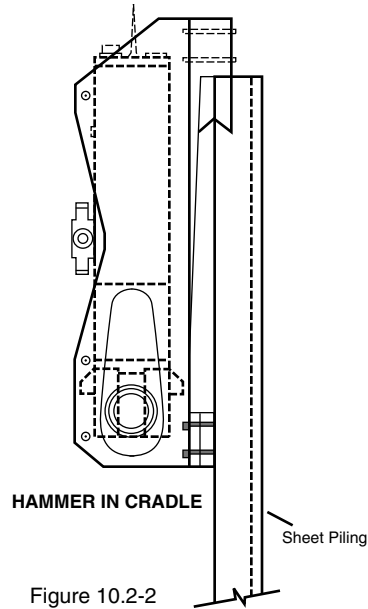

Figure 10.2-2

gether, as the driving proceeds, the joints being to the full strength of the section. If possible, however, splices should be avoided for economic reasons.

A better way of overcoming the problem is to assemble a panel of pilings horizontally on the ground, the length of the pilings being less than the headroom. The panels should be bolted to temporary walings and lifted into a vertical position.

The headroom may be increased by the excavation of a trench along the proposed line of the piling.

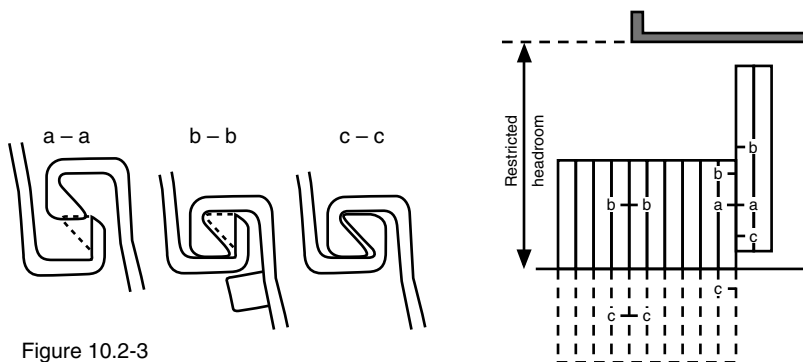

Figure 10.2-3

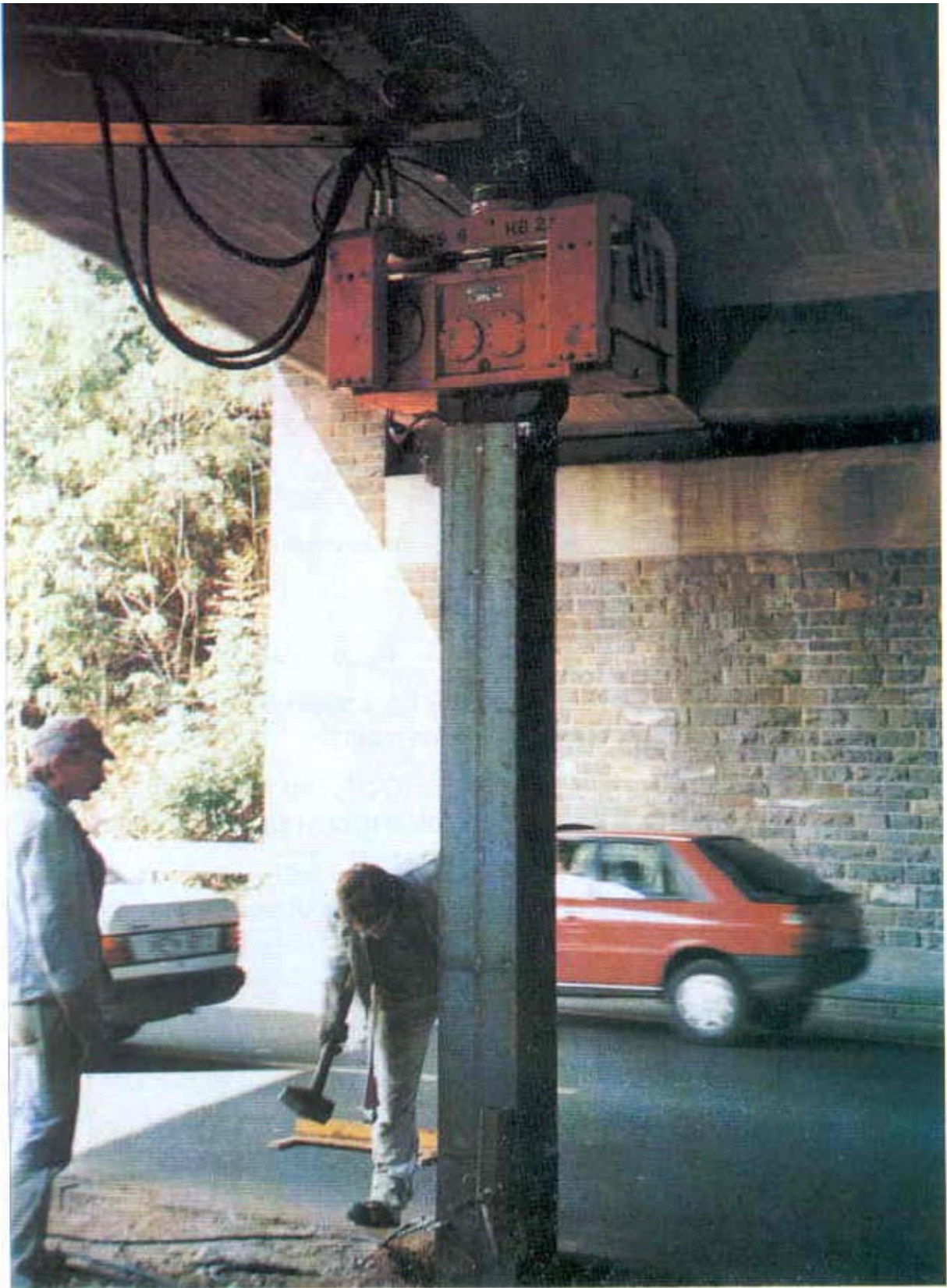

Figure 10.2-4: If the soil conditions allow the use of vibrators fixed directly to the boom of an excavator this may be a reasonable solution, as shown in the picture.

Driving is commenced using a double-acting hammer mounted in a cradle suspended at the side of the pile. As soon as sufficient headroom is available, the hammer should be moved to the normal driving position.

Alternatively, the initial penetration may be achieved by jacking the pilings down from the overhead structure, if permitted.

An alternative method is shown in figure 10-3. Over the required length at the upper end of the pile, part of the interlock is cut out so that the next pile can be interlocked.

In the soil the full interlock is maintained; in the upper part, a welded flat avoids separa-

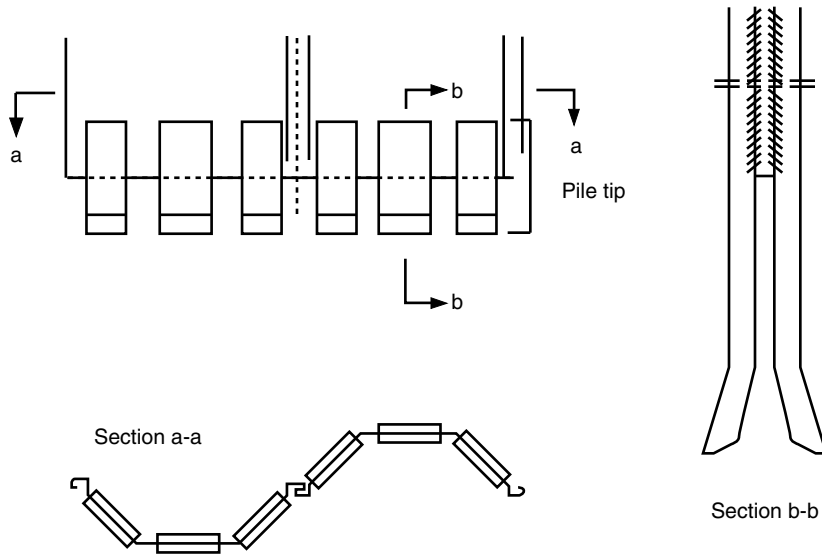

Figure 10.3

tion of interlocks.

10.3 Driving under water

When pilings have to be driven below water level, a follower should be inserted between the hammer and the pile head, with the follower being of such length that the hammer is always above water.

Double-acting hammers, working with compressed air, may work underwater. Some vibratory hammers and hydraulic hammers will also work submerged.

Driving should be done in panels to allow interlocking above water level.

10.4 Vertical loads

The bearing capacity of sheet piling for vertical loads is often ignored. However, sheet piling sections can be designed for substantial vertical loads.

Indications of the possible bearing capacity can be given if, at the end of the driving, the required penetration resistance (set) is achieved and the hammers are in accord with the soil conditions and pile section.

Test loadings may be carried out to prove the bearing capacity. Should the pile length prove to be insufficient, sheet pilings could then be spliced and driven down further.

10.5 Noise levels

The type of noise associated with piling sites depends on the method of installation employed.

For example, pile driving using a single-acting hammer results in a well-defined, impulsive type of noise. Double-acting diesel, hydraulic and air hammers also produce impulsive noise, although their striking rates can be much higher than single-acting hammers. With vibratory driving, the impulsive characteristic is virtually absent, but an intermittent

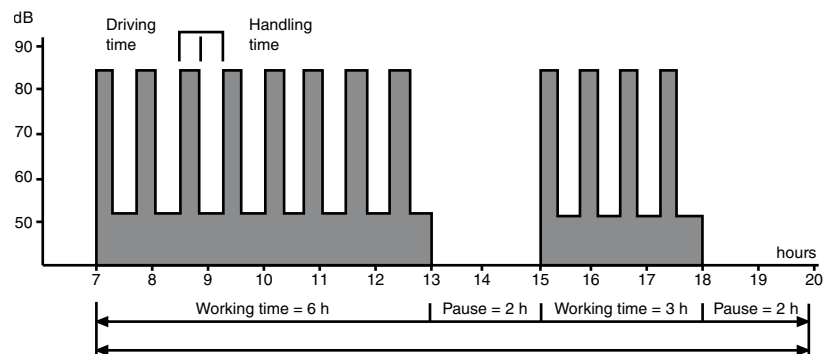

Figure 105-1: NOISES ON A PILE-DRIVING SITE VARIABLE WITH TIME

effect is still present. With jacked piling methods, the resultant noise is steady.

Highly impulsive noise is generally less acceptable than steady noise. However, other characteristics of the noise source play an important part in determining the acceptability of noise, making other construction-site noises also very annoying (trucks, etc.). Fortunately, the duration of pile driving is usually short in relation to the length of the construction work as a whole.

Also to be taken into consideration is the short-term effect of the driving cycles, which

has an influence on the definition of limit values.

The following are characteristic noise levels for the different pile drivers:

- Impact hammers 90-115dB (A)
- Rapid blow hammers 85-110dB (A)
- Vibratory hammers 70-90dB (A)
- Presses 60-75dB (A)
- Measurements at 23ft./7m from the machine.

Noise can be reduced at the source; or, when that is not possible, screening can reduce the amount of noise reaching the neighborhood. Reductions usually achieved may be to 10dB (A). Typical values for the intensity of sound in different areas are given in the following table:

- Noisy factory/workshop 90dB (A)
- Busy street 85dB (A)
- Radio at full volume 70dB (A)
- Normal speech 55/63dB (A)

- Residential area 35dB (A)

Typical noise levels are shown in the following table:

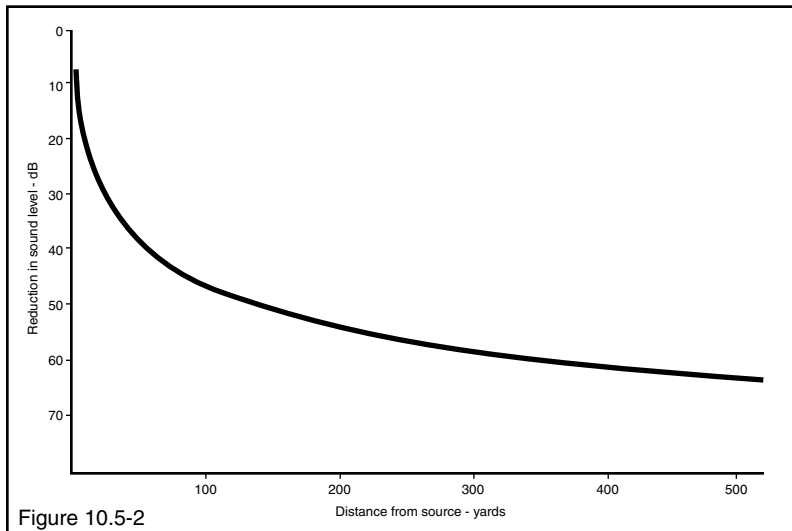

Figure 10.5-2

- Piling hammer 110dB (A)
- Crawler crane 100dB (A)
- Unsilenced pneumatic breaker 90dB (A)



Figure 10.5-3



Figure 10.5-4

Compressor 85dB (A)
Measurements at 23ft./7m from the machine

The arbitrary distance of 23ft./7m between the machine and the measuring point is another important factor. All sounds are attenuated with distance. The further sound travels through the air from the source, the less powerful it becomes. The attenuation factor is approximately a reduction of 6dB (A) for each doubling of distance from the source.

The following figure shows this as a graph:

Driving assistance methods like jetting or ground pre-treatment may ease penetration and thus reduce both the noise level and the time of the driving work.

10.6 Ground vibrations caused by pile driving

10.6.1 General

When a pile is driven into the ground, some of the driving energy is transmitted into the adjacent soil and can be experienced on the surface as vibrations. The vibrations can cause discomfort to occupants of nearby buildings and may cause concern over the risk of damage to neighboring property.

A reasoned approach to damage limitation would first be comprised of either a measurement or an estimate of free ground vibrations based upon: details of the type and length of pile; the type of hammer and its energy rating; and the ground conditions. Next, an assessment of the sensitivity of the structure to the ground vibrations should be performed. Finally, a decision on some remedial action should be made. While publications are available to offer guidance on safe levels of vibration for various structural types, the conditions of the building and of the ground should also be considered.

The building may already be stressed from differential settlement of uneven loading to the point that a small dynamic strain may be sufficient to trigger damage.

Consider a mass falling onto the head of a pile, partly embedded in the ground: a comprehensive stress wave is initiated which travels down the pile. Energy propagates outwards from the shaft of the pile with a near-cylindrical expanding wave front.

When the compression waves reach the toe of the pile, a large proportion

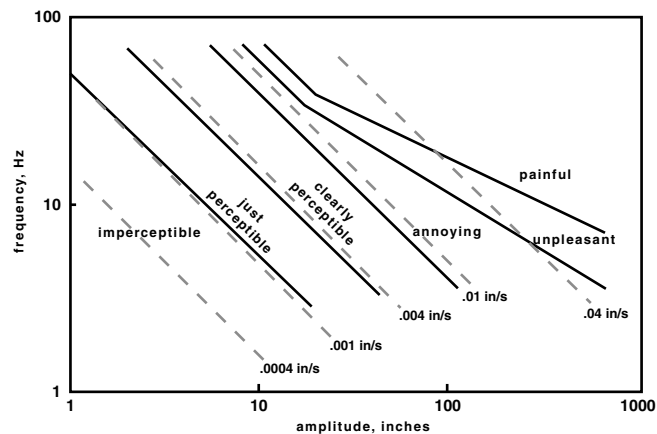

Figure 10.6.3: Reiher-Meister scale, with imposed velocities

of the remaining energy is absorbed, causing deeper penetration of the toe into the ground. It is probable that this action will induce compressional waves in the soil, which expand outward from the toe in a spherical wave front with geometrical attenuation.

The compression wave traveling down the pile will cause lateral expansion due to Poisson's ratio effect, which in turn may generate compressional waves in the ground. The tendency of the pile to "whip" laterally may generate surface waves of the Rayleigh wave form, which may also contribute to the ground-wave composition.

Vibrations from these various sources of disturbance will arrive at a point on the ground surface nearby, in a complicated form, with the various components superimposed because the distances from the source are too short to allow waves of different propagation velocities to separate.

As the waves expand, the energy decreases as a result of geometric attenuation and material damping.

10.6.2 Measurement systems

Whether signals are transient, caused by an impact hammer, or continuous and periodic (when excited by a vibratory driver), a measurement system will comprise transducers (e.g., geophones) that produce electrical signals proportional to vertical and horizontal vibrations and a system for display of the signals, perhaps with a processing facility.

Estimations of vibrations may be made following various published recommendations, but site measurements are to be preferred.

10.6.3 Sensitivity of humans to vibration

There is no doubt that the human body is a highly sensitive transducer with respect to ground vibrations, and it is suggested that a common threshold of perception of vibration is about .004-.019in./0.1-0.5mm per second. It is typical for people to overestimate perceived vibration.

The widely used Rieher-Meister scale of human sensitivity to vertical vibration offers a simple reduction; this is particularly true when equivalent particle velocities are superimposed.

10.6.4 Evaluation of the vibration effect

The response of a structure to a defined free-ground vibration signal can be evaluated either by a dynamic soil-structure interactive analysis, which is appropriate only to specialist structures; or by an empirical approach based upon limiting vibration levels. Further guidance is available from several European codes and a number of other publi-

cations. The possibility of vibration magnification by flexible floors in buildings should be noted.

10.6.5 Recommendations to reduce the effect of vibrations

The worries of householders, and the probable number of complaints, can be reduced if neighbors of a piling site are visited and: a) are given a clear description of the extent and duration of the activity; and b), are given an explanation of the relatively low probability of structural damage, despite their human perception of vibrations. On the site itself, the major variable is the choice of hammer and its mode of operation so as to best control energy input.

Impact hammers may be controlled by the operator in terms of drop height or energy input; and ground vibrations can be reduced if site measurements or observations dictate this, particularly at shallow toe penetrations.

Vibratory hammers are very effective pile drivers in granular soils and usually generate only modest vibrations. The vibrations, however, are continuous and periodic, and they may cause problems if a nearby building element has a resonance at a similar frequency. Also, these vibrations attenuate rapidly, which may be a factor if a sensitive building is at a critical distance from the source. Pile jacking systems may be appropriate when soil conditions allow.

It may also be of benefit to use jetting or pre-drilling in conjunction with any of the above driving systems.

Whatever hammer type is used, good driving practice – leading to axial impact on the pile, with suitable guidance to the pile to limit whip – will allow driving to continue with a minimum of disturbance or damage risk to neighbors and their property.

The final recommendation: if it seems a building may be at risk – or that its occupants are worried – then before-and-after surveys should be undertaken so that any induced damage can be evaluated, or repaired, whether the damage was caused: by vibration alone; by vibration as a trigger when superimposed upon other strains; or as a result of piling-induced differential settlement.

11. Flat Web Sheet Piling

11.1 General

Flat web sheet pilings are intended specifically for the construction of cylindrical walls, generally closed, bounding an earth fill. They are used mainly for the construction of

cofferdams, dock walls and dolphins.

Because of their low flexural rigidity, the straight web sections require careful storing, handling and lifting.

In order to compensate for this lack of bending resistance, special attention must also be paid to the method of guiding during installation.

11.2 Storing

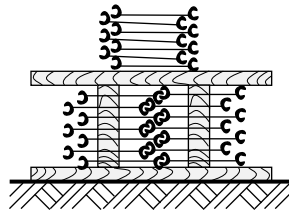

Figure 11.2-1: SIDE ELEVATION

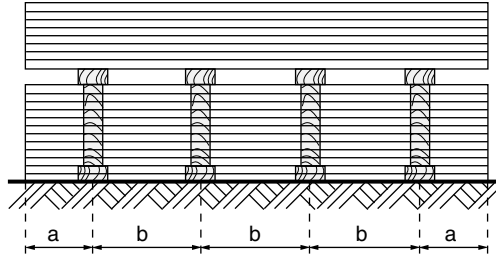

Figure 11.2-2: ELEVATION

Incorrect storing may in some cases lead to permanent deformation which, in turn, may make it difficult – or perhaps even impossible – to interlock the pilings.

They can be stacked on top of each other provided they are offset sideways so that the interlocks are situated alternately in the same vertical plane.

It is a good idea to insert wood packing between each pile; but it is also possible to stack several pilings, provided that the bottom pilings are not overstressed (Figure 11-1).

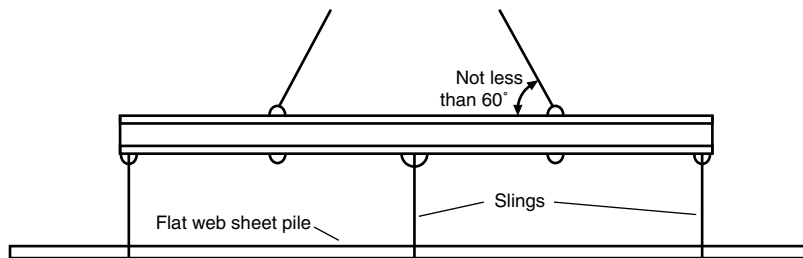

Fig. 11.3: LIFTING BEAM

Enough wood spacers must be placed along the length of the pilings to limit deformations (Figure 11-2).

Packing for stacking flat web sheet pilings (Applicable to site storage and transport)

- Overhang (a) preferably not over 5ft./1.5m
- Spacing of packings (b) preferably not over 10ft./3m

11.3 Handling

When sheet pilings have to be moved from the horizontal storage position to another storage location, then either lifting beams (Figure 11-3) or brackets made from pile sections threaded in the interlocks prior to lifting should be used.

11.4 Lifting

If setting pilings up to 50ft./15m long in the vertical position, only the point of support near the top is necessary.

Handling holes are normally provided on all pilings; but if their use is inconvenient, a cable choker biting on wood blocks can be used instead. In order to prevent accidental release, the choker should be connected via a cable and hook, to hold the lower end of the pile.

This method of setting the pile makes it possible to reduce the boom height of the crane required for handling.

Flat web sheet piling in excess of 50ft./15m should be lifted at two, or even three, points by a lifting (or spreader) beam especially equipped for this purpose, in order to avoid plastic distortions.

11.5 Driving operation

11.5.1 Template

The key to fast, economical construction of circular cell cofferdams is an efficient template to guide setting and driving of sheet piling. It must be sturdy enough to withstand a large number of re-uses and accurate enough to ensure closure of the circle of sheet pilings.

Design and shape of the template obviously depend on cofferdam size and site conditions. The selection of the material used in their fabrication is dependent upon whether

a floating or fixed guidance is appropriate to a particular situation.

Generally the template is positioned inside the cell; but of course, alternative solutions are feasible (e.g., the guide placed outside the cell) or a combination outside-inside structure.

Double-level templates supported on temporary pilings are more common.

The customary design is to have two horizontal circular templates three-dimensionally connected by vertical bracing members.

With very long pilings, it might be advisable to provide additional circular templates to give better guidance.

A securely designed work platform will facilitate some of the placing operations of the pilings. Exact calculation of the template diameter is very important to ensure correct pile positioning.

11.5.2 Setting flat web sections

When the template is securely anchored, the sheet pilings are positioned around its periphery and the whole cell is thus erected prior to driving.

Marks should be placed at the circumference of the working platform to ensure that the sheet pilings are spaced properly.

Extreme care must be taken in setting, so that the pilings remain plumb and do not lean.

Frequent checking of the verticality of the bars is very important and often saves time in the long run.

It is essential that junction pilings be located accurately and positioned plumb. The pilings should be set alternately from the two junctions using the center pile, or pair of pilings, to complete the arc.

When this method is adopted, it should allow the free sliding of the closure pile. If necessary, a lifting of the adjacent pilings will facilitate this.

Setting piling in only one direction will magnify any errors. The first two pilings of the interconnecting arcs have to be set prior to cell filling in order to facilitate the setting of the remaining pilings of the arc.

11.5.3 Driving

Either vibratory or impact hammers can achieve the driving of straight web sheet pilings. In all cases, the equipment should be light and easy to handle in order to facilitate

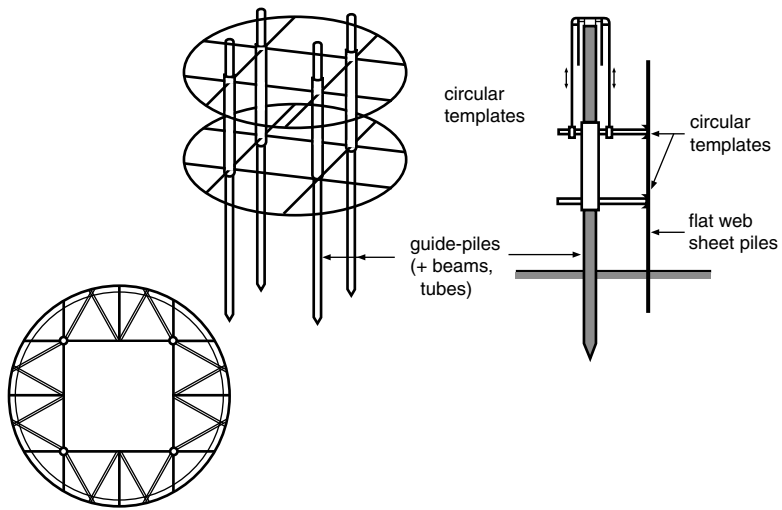

Figure 11.5.3-1: TEMPLATE - Typical layout of a template for flat web sheet piles.





12. Extracting

12.1 General

When piling is intended to serve only as a temporary protection for permanent construction work, it can be extracted for re-use by means of suitable extractors, either of the impact, vibratory or jacking type.

12.2 Measures to be taken before and during driving

When extraction of pilings is foreseen, the following details must be taken into account: sheet pile section, sheet pile length, driving depth, subsoil data, embedded time and driving method. All these factors may: create problems; require very heavy extraction equipment; or even make recovery impossible.

A lubricant on the inside of the interlocks reduces the friction.

In dense soils the use of sacrificial toe-protection shoes may be helpful. Immediately before driving, the shoe is put on the pile toe without welding. The protrusion of the shoe over the sheet pile creates a loosened soil zone along the surface of the pile.

For an evaluation of the required pulling force, the previous establishment of a driving record for each pile is very useful. This identifies the pilings with the lowest resistance, thus defining the starting point for the extraction work.

If driving records of the pilings are not available, then the first pile to be extracted should be selected with care.

Pilings near the center of a wall should be tried until one pile begins to move. If difficulty is experienced, then a few driving blows with an impact hammer may be used to loosen a pile.

It may also be necessary to reinforce the head of the pilings to aid the successful extraction of the initial pile.

Accurate driving of the pilings in the soil makes extraction easier.

It may be necessary to increase the section to ensure good drivability and thereby minimize damage to the pilings.

12.3 Extraction

Vibratory and extracting hammers of various sizes are available. They loosen the pile from its initial position so that it moves via the pulling force of the crane. The limit values of the extracting hammers and crane loads given by the manufacturer should be respected.

The connection between pile and vibratory hammer is made by hydraulic clamps, shackles and bolts.

Sometimes drilling or jetting is necessary to facilitate the extraction operation.



North American Steel Sheet Piling Association

To receive a hard copy of the latest NASSPA NOTEBOOK be sure to fill out the below information or, for immediate response, please go to www.nasspa.com/contact.

Place stamp here.

Name _____
Company _____
Address _____
City _____
State _____ Zip _____
Phone _____
Email _____

NASSPA
PO Box 2013 - #378
Austin TX 78768

You are a:
 Engineer Contractor Owner Other

Have you ever used steel sheet piling in a permanent application?
 Yes NO



NASSPA
North American Steel Sheet Piling Association

