



INDEX

Gerdau Ameristeel Company Profile ..	3
Introduction to Sheet Piling.....	4
PZ Properties	7
PZC-B Properties.....	8
PZC Properties	9
Setting & Driving Tips - Z Profile	15
PS (Flat Sheet) Piling	17
PS Properties	20
Setting & Driving Tips - PS Profile	25
Corrosion	26
Specifications	31

Gerdau SSP

COMPANY PROFILE

Gerdau Ameristeel is the largest producer of steel sheet piling in North America. With an annual capacity to manufacture more than 12 million tons of mill finished products, it is the fourth largest steel company and the second largest minimill steel producer in North America. Through an integrated network of minimills, steel scrap recycling facilities, and downstream operations, Gerdau Ameristeel provides service and products to customers around the world.

In September of 2007, Gerdau Ameristeel acquired Chaparral, including its operations that produce hot-rolled sheet piling. "Chaparral Sheet Piling" has now been re-branded to "Gerdau Sheet Piling."

Gerdau Ameristeel's common shares are traded on the New York Stock Exchange under the symbol GNA. The company is headquartered in Toronto, with executive offices in Tampa, Florida.

TEXAS OPERATION – PS FLAT SHEETS

The facility is located 30 miles (48 kilometers) southwest of Dallas, Texas, in the city of Midlothian. This operation is comprised of an automobile shredder, metals separator, two electric arc furnaces for the melting operations, and three rolling mills. Two rolling mills produce hot-rolled structural shapes, including beams up to 24 inches (610 mm), channels up to 12 inches (305 mm), and PS (flat web) sheet piling. The third rolling mill includes a bar mill which produces hot-rolled round bars for specialty steel forging applications and reinforcing bars for construction. The combined capacity of the Texas operation is 1.8 million tons per year.

VIRGINIA OPERATION – Z PROFILE

The state-of-the-art \$500 million steel facility was built in 1998 in Petersburg, Virginia, near the city of Richmond. This mill produces hot-rolled structural shapes including beams up to 36 inches (915 mm) and the full range of Z-profile sheet piling sections. Employing more than 450 people, this facility is home to the most modern sheet piling mill in the world with an annual capacity of just over 1.0 million tons. The facility is comprised of an automobile shredder, electric arc furnace melting operation, and rolling mill.



GERDAU SHEET PILING

INTRODUCTION TO SHEET PILING

Steel sheet piling is a rolled structural steel section with interlocks on the flange tips which enable the joining of sections to form a continuous wall.

STEEL SHEET PILING APPLICATIONS

Permanent and temporary applications for steel sheet piling cover the entire construction industry:

- Marine
- Foundations
- Environmental
- Transportation

The interlocks permit the sheets to be set and driven as a continuous wall, which resists the movement of soil and water.

STEEL SHEET PILING BENEFITS AND ADVANTAGES

- Readily available
- Produced from recycled material
- Reduced space requirements
- Material longevity
- Reduced construction time
- Typically lower overall construction costs

GERDAU SHEET PILING SECTIONS MAY BE DIVIDED INTO TWO TYPES BASED ON THEIR END USE:

1) Z-PROFILES – sections used for beam strength in cantilevered and braced construction

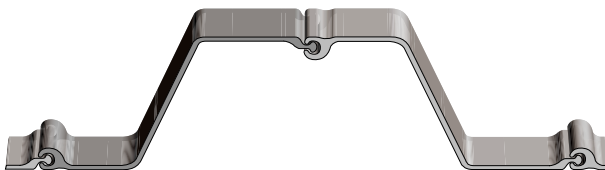

- Retaining walls
- River cofferdams
- Braced excavations
- Tied bulkheads
- Bridge abutments
- Cut-off walls
- Foundations
- Levee construction

2) PS-PROFILES – sections used for interlock strength in cellular applications



- Bridge abutments
- Cofferdams to construct locks and dams
- Graving docks
- Mooring dolphins
- Bridge pier protection
- Levee construction
- Deep draft bulkheads and docks
- Erosion control

▶ London Avenue Canal, New Orleans



▶ IHNC Levee Rebuilding, New Orleans



Z-PROFILES (PZC AND PZ)

Z-Profiles, with their optimum distribution of material, are the most efficient sheet piling sections available for bending strength.

With the interlocks located on the outer fibers of the wall - rather than at the center line, as is the case with Arch or U-Profile sheet piling sections - the wall designer is assured of the published section modulus. The Z-Profile is the optimal section for both weight and strength.



INTERLOCK

The ball-and-socket interlock was introduced in the United States in the late 1930's and continues to be the interlock preferred by piling contractors and engineers.

Gerdau Z-Profiles are produced with the ball-and-socket interlock in Petersburg, Virginia.

The advantages of the ball-and-socket interlock over Larsen and other interlocks are:

- Most rugged, durable, and flexible interlock available.
- Ideal for reuse in multiple projects.
- Higher "buy back/resale" value.
- Easier setting, driving, and extraction.
- Highest interlock "T" (tensile) strength relative to other Z-Profiles.
- Flexibility when setting - allows adjustment to wall length by swinging (rotating) sheets.

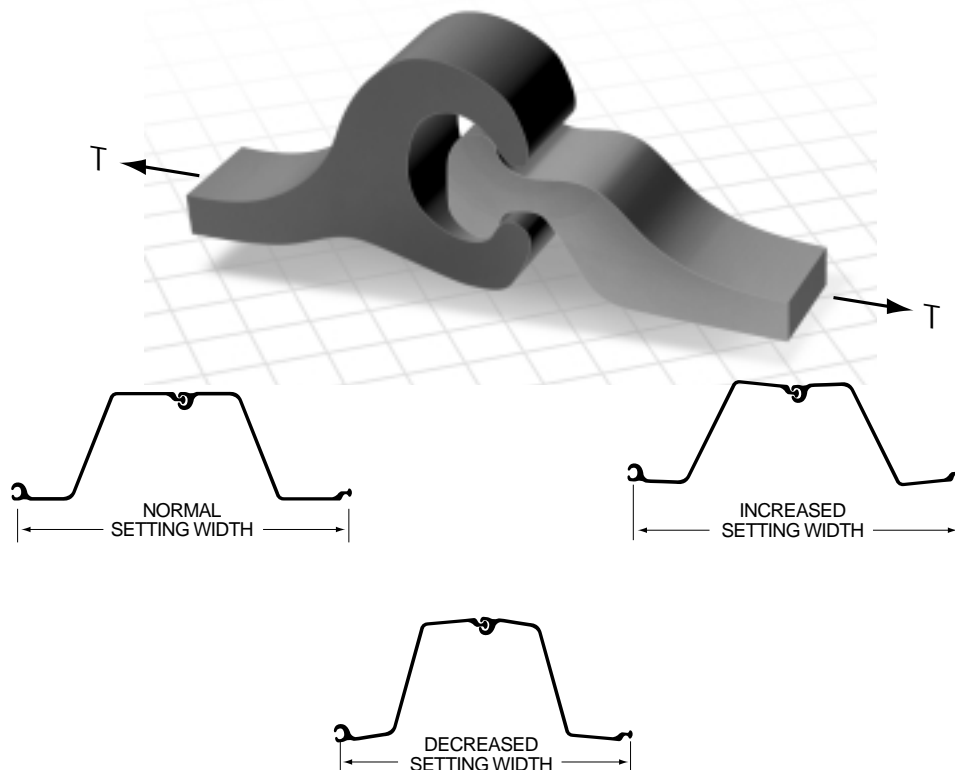

GERDAU SHEET PILING

GERDAU Z-PROFILE ADDITIONAL ADVANTAGES:

Only Gerdau sheet piling sections incorporate geometry based upon the testing and research findings of Dr. Richard Hartman regarding transverse bending stresses. Dr. Hartman demonstrated that both longitudinal stresses and transverse stresses act within sheet piling sections.

Longitudinal stresses are oriented in a vertical direction and are familiar to all engineers who design sheet piling structures. Accepted engineering practice is to design to 0.65 F_y in longitudinal bending. Transverse stresses are oriented in a horizontal direction and are dependent upon section geometry. In fact, transverse stresses can exceed longitudinal stresses in poorly proportioned sheet piling sections. This is very important because transverse stresses diminish the useable longitudinal stress on a one-to-one basis.

Gerdau sections are designed based on this research, to minimize the effects of transverse stresses and maintain the structural integrity of the section.

More information on Dr. Hartman's research can be found at www.transversestress.com

PZ AND PZC PROFILES AND PROPERTIES

- PZ** Traditional North American piling sections with ball-and-socket interlocks.
- PZC** Newest generation of wider, lighter and stronger sheet piling sections with ball-and-socket interlocks.

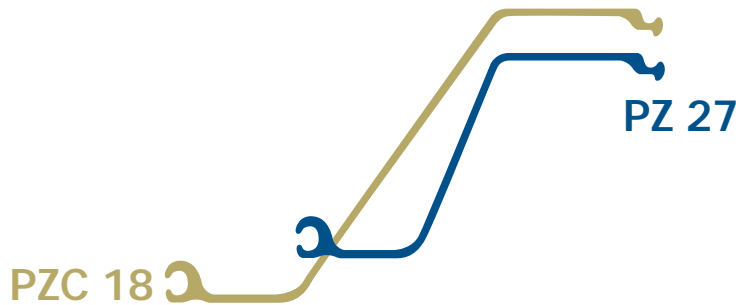

Width	25.0 in.	18.0 in.
Weight	24.2 lbs/ft²	27.7 lbs/ft²
S.M.	33.5 in.³/ft	31.0 in.³/ft

PZC sections are the “latest generation” of sheet piling profiles and were developed to be lighter, wider, and stronger than the older traditional PZ sections. PZC profiles are named for their strength in metric designations. For example, PZC 18 has a Section Modulus of 1,800 cm³/meter. **PZC profiles should always be the designer's first choice in order to provide the end user the most economical retention wall with the most efficient ratio of section modulus to weight. PZC profiles are listed on page 9.**

GERDAU PZ SHEET PILING PROPERTIES

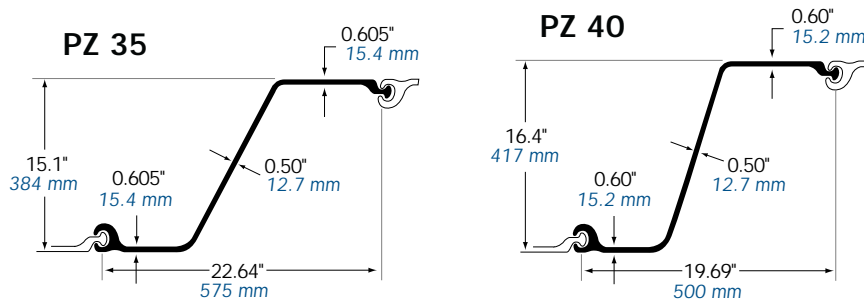

Section	Per Single Section									Per Unit of Wall				
	Nominal Width in. (mm)	Wall Depth (Height) in. (mm)	Web Thickness in. (mm)	Flange Thickness in. (mm)	Area in. ² (cm ²)	Weight lbs/ft (kg/m)	Moment of Inertia in. ⁴ (cm ⁴)	Section Modulus in. ³ (cm ³)	Total Surface Area ft ² /ft (m ² /m)	Nominal Coating Area* ft ² /ft (m ² /m)	Area in. ² /ft (cm ² /m)	Weight lbs/ft ² (kg/m ²)	Moment of Inertia in. ⁴ /ft (cm ⁴ /m)	Section Modulus in. ³ /ft (cm ³ /m)
PZ 22							LESS EFFICIENT use PZC 13							
PZ 27							LESS EFFICIENT use PZC 18							
PZ 35	22.64	15.10	0.500	0.605	19.40	66.0	697.1	92.3	5.83	5.33	10.28	35.0	369.5	48.9
	575	384	12.7	15.4	125.2	98.2	29,015	1,515	1.78	1.62	217.7	170.8	50,455	2,635
PZ 40	19.69	16.40	0.500	0.600	19.28	65.6	824.8	100.6	5.83	5.33	11.75	40.0	502.7	61.3
	500	417	12.7	15.2	124.4	97.6	34,330	1,650	1.78	1.62	248.7	195.2	68,645	3,300











*Both sides of sheet; excludes socket interior and ball of interlock.

PZ sheet piling is a traditional sheet piling profile produced in North America. These sections are named for weight. For example, PZ 35 weighs 35 pounds per square foot of wall.



PZC-B HIGH SECTION MODULUS PROPERTIES

The following table represents a limited overview of possible PZC-B combinations. Please refer to www.sheet-piling.com for an extensive solution list and complete details on other PZC-B combinations. This website also has tools available to estimate material requirements. For further assistance, please contact us directly.

Section	Solution Type	Section Modulus	Width	Weight*			Moment of Inertia	Nominal Coating Area in Panel Width**		Beam***	Sheet Pile
				in. ³ /ft of wall (cm ³ /m of wall)	in. (mm)	60%		80%	100%		
							in. ⁴ /lin. ft of wall (cm ⁴ /lin. m of wall)	ft ² /lin. ft of panel (m ² /lin. m of panel)	ft ² /lin. ft of panel (m ² /lin. m of panel)		
PZC-B 29		54.4	70.6	29.4	33.3	37.2	729	7.02	19.91	W30 x 90	PZC 13
		2,920	1,793	143.4	162.4	181.5	99,600	2.14	6.07		
PZC-B 34		62.9	68.3	31.1	35.1	39.1	1,043	6.94	20.20	W30 x 108	PZC 13
		3,380	1,734	151.7	171.4	191.1	142,000	2.12	6.16		
PZC-B 39		72.1	69.3	32.4	36.3	40.3	1,306	6.76	20.91	W33 x 118	PZC 13
		3,880	1,760	158.0	177.4	196.8	178,000	2.06	6.37		
PZC-B 43		80.1	69.3	34.4	38.4	42.4	1,450	6.90	20.92	W33 x 130	PZC 13
		4,310	1,761	168.0	187.4	206.8	198,000	2.10	6.38		
PZC-B 46		85.3	69.8	35.1	39.0	43.0	1,655	6.94	21.49	W36 x 135	PZC 13
		4,590	1,772	171.2	190.4	209.7	226,000	2.12	6.55		
PZC-B 52		96.5	69.8	37.6	41.6	45.5	1,872	6.95	21.50	W36 x 150	PZC 13
		5,190	1,773	183.7	203.0	222.2	256,000	2.12	6.55		
PZC-B 59		109.5	69.9	41.0	45.0	48.9	2,127	6.95	21.50	W36 x 170	PZC 13
		5,890	1,775	200.3	219.6	238.8	290,000	2.12	6.55		
PZC-B 72B		133.3	70.0	47.8	51.7	55.7	2,595	6.97	21.53	W36 x 210	PZC 13
		7,170	1,778	233.4	252.6	271.8	354,000	2.12	6.56		
PZC-B 89		166.0	83.9	56.8	60.5	64.2	3,223	8.30	31.80	W36 x 160	PZC 13
		8,930	2,131	277.4	295.4	313.4	440,000	2.53	9.69		
PZC-B 126		235.1	78.5	76.0	79.9	83.9	4,575	8.34	31.86	W36 x 210	PZC 18
		12,600	1,994	371.1	390.3	409.6	625,000	2.54	9.71		

* Length of intermediate sheet piling sections as a percent of the beam's length.

** Excludes socket interior and ball of interlock.

*** Connectors are BBS (single leg) M & F welded on flange tips. Weld requirements should be specified by design engineer.

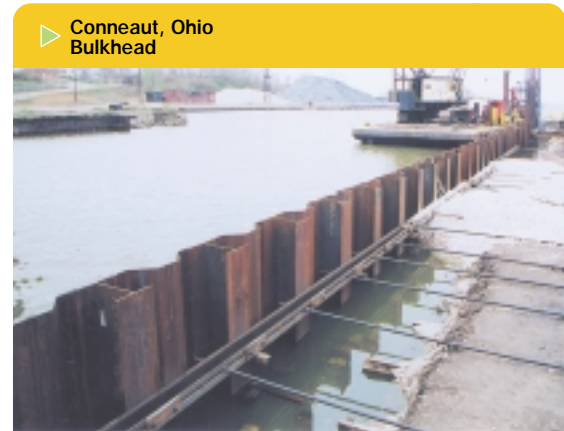
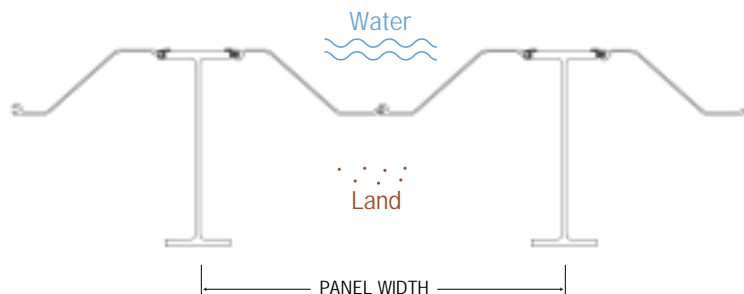

PZC SHEET PILING PROPERTIES

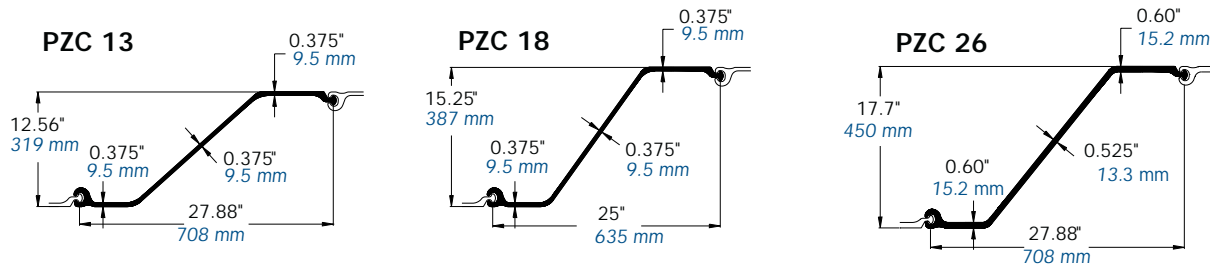

Section	Nominal Width in. (mm)	Wall Depth (Height) in. (mm)	Web Thickness in. (mm)	Flange Thickness in. (mm)	Per Single Section						Per Unit of Wall			
					Area in. ² (cm ²)	Weight lbs/ft (kg/m)	Moment of Inertia in. ⁴ (cm ⁴)	Section Modulus in. ³ (cm ³)	Total Surface Area ft ² /ft (m ² /m)	Nominal Coating Area* ft ² /ft (m ² /m)	Area in. ² /ft (cm ² /m)	Weight lbs/ft ² (kg/m ²)	Moment of Inertia in. ⁴ /ft (cm ⁴ /m)	Section Modulus in. ³ /ft (cm ³ /m)
PZC 13	27.88	12.56	0.375	0.375	14.82	50.4	353.0	56.2	6.10	5.60	6.38	21.7	152.0	24.2
	708	319	9.5	9.5	95.6	75.1	14,695	920	1.86	1.71	135.1	106.0	20,755	1,300
PZC 14	27.88	12.60	0.420	0.420	16.15	55.0	381.6	60.5	6.10	5.60	6.95	23.7	164.3	26.0
	708	320	10.7	10.7	104.2	81.8	15,890	990	1.86	1.71	147.2	115.5	22,445	1,400
PZC 18	25.00	15.25	0.375	0.375	14.82	50.4	532.2	69.8	6.10	5.60	7.12	24.2	255.5	33.5
	635	387	9.5	9.5	95.6	75.1	22,155	1,145	1.86	1.71	150.6	118.2	34,890	1,800
PZC 19	25.00	15.30	0.420	0.420	16.16	55.0	576.3	75.3	6.10	5.60	7.75	26.4	276.6	36.1
	635	388	10.7	10.7	104.2	81.8	23,990	1,235	1.86	1.71	164.1	128.8	37,780	1,945
PZC 25	27.88	17.66	0.485	0.560	20.40	69.4	938.7	106.3	6.65	6.15	8.78	29.9	404.1	45.7
	708	449	12.3	14.2	131.6	103.3	39,075	1,740	2.03	1.87	185.9	145.9	55,190	2,455
PZC 26	27.88	17.70	0.525	0.600	21.72	73.9	994.3	112.4	6.65	6.15	9.35	31.8	428.1	48.4
	708	450	13.3	15.2	140.1	110.0	41,390	1,840	2.03	1.87	197.9	155.4	58,460	2,600
PZC 28	27.88	17.75	0.570	0.645	23.22	79.0	1,057.1	119.1	6.65	6.15	10.00	34.0	455.1	51.3
	708	451	14.5	16.4	149.8	117.6	44,000	1,950	2.03	1.87	211.6	166.1	62,145	2,755

*Both sides of sheet; excludes socket interior and ball of interlock.



COVER PLATED PZC 26 PROPERTIES (TO OBTAIN HIGHER SECTION MODULI)

Section	Nominal Width in. (mm)	Plate Size in. (mm)	Per Single Section				Per Unit of Wall			
			Area in. ² (cm ²)	Weight lbs/ft (kg/m)	Total Surface Area ft ² /lin. ft (m ² /m)	Nominal Coating Area* ft ² /lin. ft (m ² /m)	Weight		Moment of Inertia in. ⁴ /lin. ft (cm ⁴ /m)	Section Modulus in. ³ /ft (cm ³ /m)
							Plates Full Length lbs/ft ² (kg/m ²)	Plates Half Length lbs/ft ² (kg/m ²)		
PZC 37-CP (PZC 26)	27.88	3.5 x 0.9375	28.28	96.2	6.96	6.46	41.4	36.6	673.3	68.8
	708	89x24	182.5	143.1	2.12	1.97	202.2	178.7	91,900	3,700
PZC 39-CP (PZC 26)	27.88	3.5 x 1.125	29.60	100.6	7.03	6.53	43.3	37.6	728.3	73.0
	708	89x29	190.9	149.7	2.14	1.99	211.6	183.4	99,500	3,930
PZC 41-CP (PZC 26)	27.88	3.5 x 1.25	30.47	103.6	7.07	6.57	44.6	38.2	766.1	75.8
	708	89x32	196.6	154.2	2.15	2.00	217.8	186.6	104,600	4,080

*Both sides of sheet; excludes socket interior and ball of interlock

Notes: • Best economy is obtained when plate length is limited to area of high moment.

• Cover plate length depends upon moment curve.

• Fllet weld should be sized to adequately resist design loads. Weld requirements should be specified by design engineer.

PS (FLAT SHEET) PILING PROPERTIES

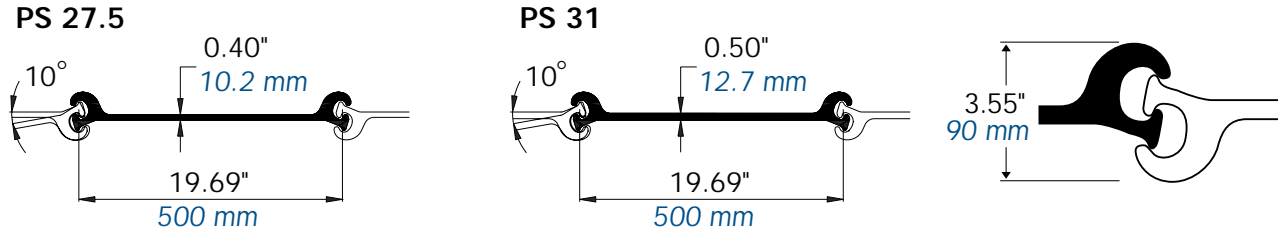

Section	Nominal Width in. (mm)	Depth (Height) in. (mm)	Wall Depth (Height) in. (mm)	Web Thickness in. (mm)	Per Single Section						Per Unit of Wall			
					Area in. ² (cm ²)	Weight lbs/ft (kg/m)	Moment of Inertia in. ⁴ (cm ⁴)	Section Modulus in. ³ (cm ³)	Total Surface Area ft ² /ft (m ² /m)	Nominal Coating Area ² ft ² /ft (m ² /m)	Area in. ² /ft (cm ² /m)	Weight lbs/ft ² (kg/m ²)	Moment of Inertia in. ⁴ /ft (cm ⁴ /m)	Section Modulus in. ³ /ft (cm ³ /m)
PS 27.5	19.69	2.83	3.55	0.40	13.26	45.1	5.0	3.2	4.50	3.64	8.08	27.5	3.0	1.9
	500	72	90	10.2	85.5	67.1	207	52	1.37	1.11	171.0	134.2	414	103
PS 31	19.69	2.83	3.55	0.50	14.96	50.9	5.0	3.2	4.50	3.64	9.11	31.0	3.0	1.9
	500	72	90	12.7	96.5	75.7	207	52	1.37	1.11	192.9	151.4	414	103

*Both sides of sheet: excludes interior of interlock.

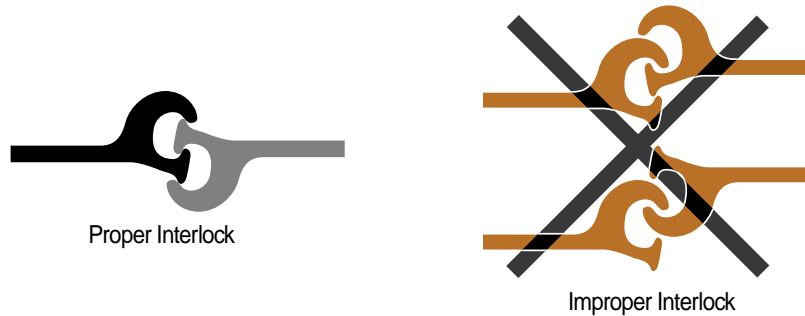

Grade	Minimum Interlock Strength ⁽¹⁾	Minimum Swing ⁽²⁾
A328	16 kips/in. (2,800 kN/m)	10 degrees
A572-50	20 kips/in. (3,500 kN/m)	10 degrees
A572-60	24 kips/in. (4,200 kN/m)	10 degrees

Higher interlock strengths are available but obtainable swing may be reduced in interlock strengths above 24 kips/in (4,200 kN/m).

- (1) These minimum ultimate interlock strengths assume proper interlocking of sheets. To verify the strength of PS Sheet Piling, both yielding of the web and failure of the interlock should be considered.
- (2) Swing reduces 1.5 degrees for each 10 feet (3 meters) in length over 70 feet (21 meters).

NOTE: INTERLOCKING OF GERDAU PS SECTIONS WITH ANOTHER PRODUCER'S SECTION SHOULD NEVER BE CONSIDERED UNLESS APPROVED IN ADVANCE BY GERDAU AMERISTEEL. PS and Z-Piling sections should not be interlocked together. Gerdau PS 27.5 and PS 31 can be interlocked with each other.

CONNECTORS FOR Z-PROFILES:

Extruded or hot-rolled connections are suggested for Corners and Tees. Consistent quality control during manufacturing, combined with ease of use and efficiency of construction, make these engineered products superior to traditional fabricated sections. These connectors are readily available directly from the mill with Z-Profile sheet piling.

Advantages of connectors are:

- No welded connections.
- Delivery made with sheet piling.
- Easily transported, handled, stored and installed.
- Multiple configurations are stocked with sheet piling.

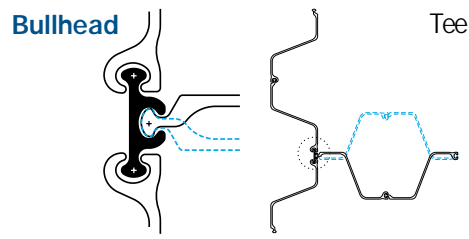
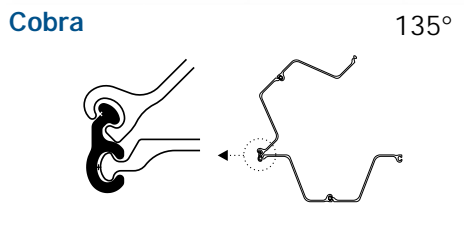
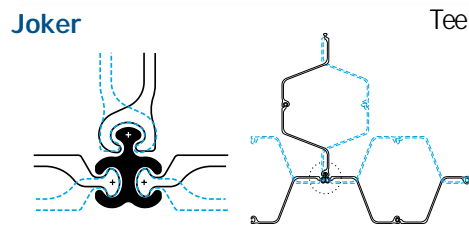
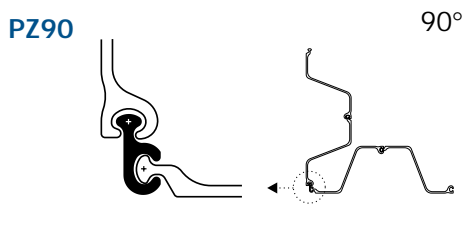
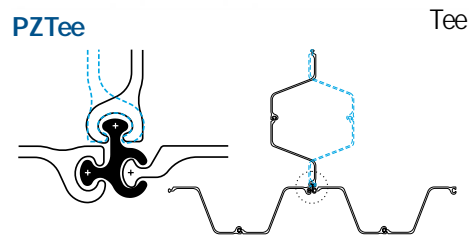
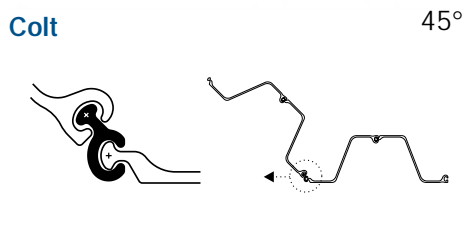

(Blue dashed lines indicate alternative configurations)

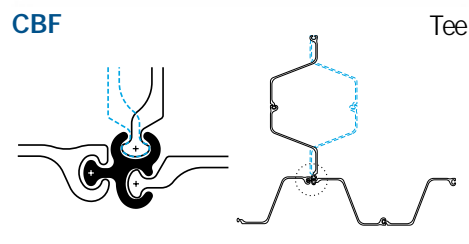

GERDAU SHEET PILING

Z-PROFILE ALTERNATIVE LAYOUTS

Because ball-and-socket dimensions are the same for all Gerdau Z-Piling sections, all Gerdau Z-piling sections can interlock with each other. Also, because of the shape of the interlock, they can be joined in either of two arrangements:



The reversed interlock arrangement can be utilized to bypass obstructions when they are encountered along the driving line or to shift the driving line.

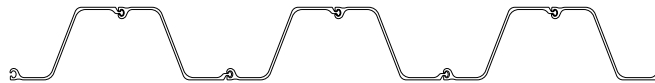

Normal Layout

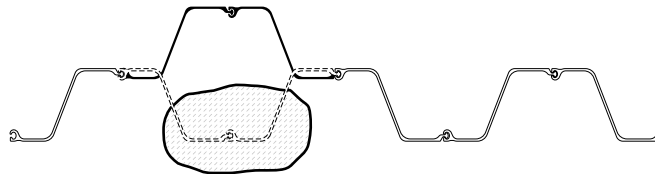

Layout to Avoid an Obstruction

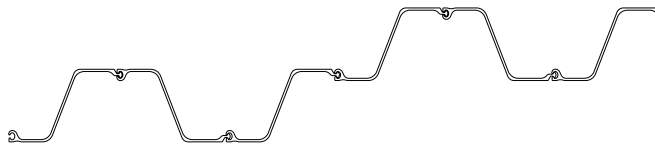

Layout to Shift the Line by the Depth of One Sheet Pile

Another variation using reversed interlocks is shown below. It is useful when reduced section modulus is acceptable and the engineer wishes to reduce the weight per square foot and/or depth of wall. In addition to the weight reduction, the laying width is increased, resulting in fewer interlocks and reduced installation time. Fewer interlocks per length of wall is important in a cut-off wall.



PZC-B HIGH SECTION MODULUS SYSTEMS

PZC-B systems are combinations of beams and PZC sheet piling (combi-walls) designed to achieve higher section modulus requirements. The primary load-carrying elements are the beams (king piles). The intermediate sheet piling, along with extruded or hot-rolled connectors, serves to close the face of the wall between the beams.

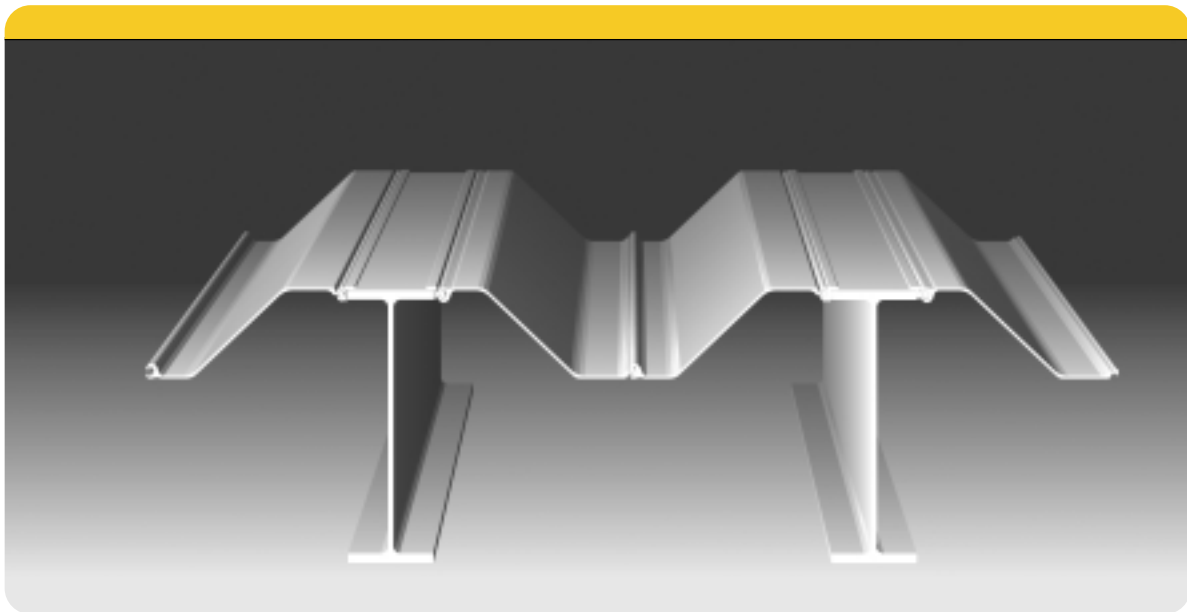
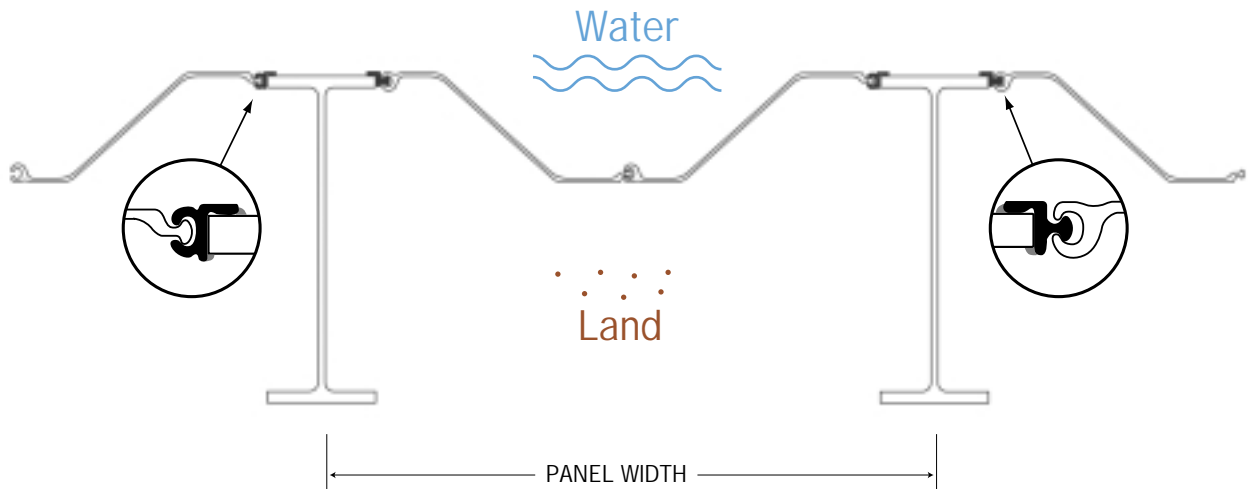

Pipe is sometimes used as the king pile in a combi-wall when very high section modulus is required. The appropriate WOF/WOM connectors for attachment to the pipe are in stock and available for shipment with sheet piling.

GERDAU SHEET PILING

PZC-B System Advantages:

- Multiple configurations available to achieve desired section modulus and delivery.
- Beams can be driven deeper into dense soils than sheet piling.
- Sheet piling length is typically 60% to 80% of the length of beams.
- Flexibility of the ball-and-socket interlock allows for easy setting of the intermediate sheet piling pair, while accommodating slight deviations inherent to the driving of the beams.
- Can be installed in less time than driving full-length heavy sheet piling in a continuous wall.

PZC-B COMBINED WALL SYSTEM INSTALLATION:

- Install the beams first using a multi-level template
- Set and drive the intermediate sheet piling pairs between driven beams

For a limited overview of PZC-B high section modulus solutions, please refer to page 8.

▶ Port of Oakland



Setting and Driving Tips for Z-Profile Sheet Piling:

Proper setting and driving techniques are beneficial to both the project and the contractor. Improper practices result in problems and costs that far out-weigh the initial expense of applying correct methods from the start. Although setting and driving techniques may vary according to the site conditions and/or the contractor's level of experience, several basic principles can be applied as outlined below, and an installation guide can be downloaded from the North American Steel Sheet Piling Association at www.nasspa.com.

Use an adequate template: The utilization of an adequate steel template will facilitate the installation process and result in a superior end product. The purpose of the template is to both properly align the sheet pile during the setting process as well as to keep the piling in alignment during the driving phase. Since a typical sheet pile weighs one ton or more, the template needs to be of rugged construction. Also, bear in mind that the template will normally be used and moved multiple times at the job site; this is another reason for a well-designed and solidly constructed template. Template must also be of correct dimensions for the piling section. An improperly dimensioned template could cause sheet binding and increase driving difficulty.

Mark the template: To maintain the published laying width of the piling, it is very important to mark the template for each pile, or pair. By following this procedure, the contractor can observe whether the line being set is gaining or losing wall length. This procedure is important for installations such as: cofferdams, which must be closed; or anchored bulkheads, where tie-rod locations are critical. Depending upon the length of the piling, the template might be one, or two or more tiers high. In order to maintain a plumb wall when installing piling lengths in excess of 50 feet (15 meters), a two-tier template is always suggested as a minimum.

Set a panel of piling: The length of the panel will vary depending upon site conditions, the contractor's experience, and other factors. In general, you might expect a panel length of 25 to 45 feet (8 to 14 meters). As each pile, or pair, is set, they may be rotated as necessary in the interlock (as shown below) in order to match the marks on the template.

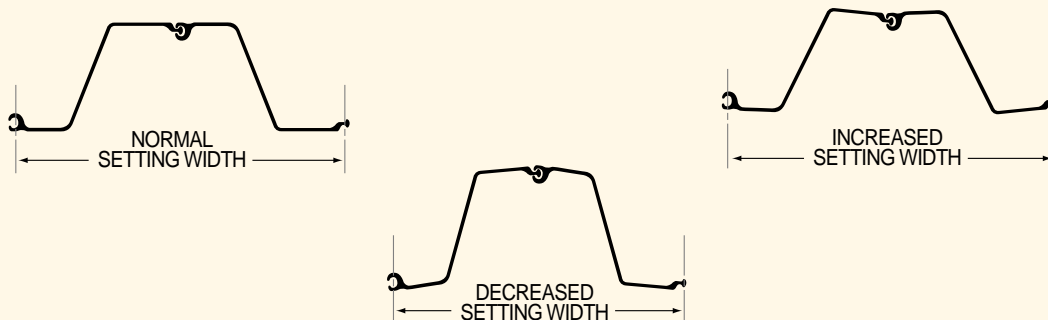

Sheet piling supplied with the interlocks crimped or welded does not offer this advantage.

Keep the piling plumb: It's of utmost importance that, as each pile or pair is set, it is plumb and secured before the next is set. Once the wall is allowed to get out of vertical alignment, the mistake will only get worse; and at some point the contractor will simply have to quit, extract the out of plumb piling, and start over. The most important tool of the pile driving crew is a long level: 4 feet (1.25 meter) or more in length, or a vertical laser.

GERDAU SHEET PILING

Set and drive with the ball-end leading: When the piling is set and driven with socket-end leading, the socket becomes clogged with soil and the ball must force the soil out of the opening. In some types of soils, such as very fine and dense sand, the resistance of the soil in the socket can be such that driving becomes impossible without damaging the piling. Under such conditions, particularly with a vibratory hammer, it is possible to actually weld interlocks together.

If for some reason the piling must be driven with the socket-end leading, such is the case when using an interlock sealant like WADIT (www.wadit.com), then place a bolt or some object in the socket at the bottom end to minimize clogging.

Drive the panel of piling in stages: Piles driven full length in one operation are more prone to deflect and go off line. This is particularly true when the soil contains debris, boulders, or other obstructions. Subsequent piles are guided by the deflected section, and within a short length of wall, pile driving comes to a halt. The piling must then be pulled, and the wall has to be restarted.

The preferred process to minimize, if not eliminate, this problem is to first set a panel of piling and then work the panel down as a unit. This is accomplished by driving the piling (singles or paired), in increments using a defined sequence. The magnitude of the increment will be determined by the soil conditions. In general, the harder the driving, the less the driving increment, perhaps 6 feet (2 meters) in easy driving, versus 3 feet (1 meter), or less, in denser soil.

Panel driving allows the piling to be guided by previously driven vertical piles, and it lessens the possibility of driving the piling out of interlock. During this phase, as during the setting process, it's important that constant attention be paid to maintaining a plumb wall. Any deviations from being plumb should be quickly corrected before things get out of hand.

Driving is ideally, and normally, accomplished by driving pairs. However, if driving becomes difficult due to obstructions or pockets of dense soil, simply drop back and drive single sheets. This is another advantage of not crimping or welding pairs.

Avoid splicing if possible: Randomly selecting Z-piles to splice could result in attempting to splice two cross sections together that do not match. This results in added time and costs.

If splicing is required, then the piling should be ordered full length from the production mill. They should be cut and match-marked at the site. These sections can then be spliced back together to reconstruct the original piling. This procedure reduces the mismatching of cross sections and improves section geometry alignment.

In order to avoid creating a plane of weakness in the wall, the splices on adjacent piling must be staggered by a minimum of 3 feet (1 meter), if feasible.

When splicing the piling, it's impossible to weld in the interlocks due to both the difficulty of welding in this area and the distortion caused by the heat from the welding. If full section modulus is required at the splice, it will be necessary to provide flange plates to make up for the loss of section modulus in the interlocks. Normal practice allows for a combination of butt-welding of the flanges and web, along with the addition of flange plates by fillet welding. Light "seal" welds around the perimeter of the interlocks will prevent the flow of water and soil through the splice.

PS SHEET PILING



Gerdau PS “Flat Sheet Piling” sections are produced with a thumb and finger interlock in Midlothian, Texas. These sections consist of a web with interlocks at each end. The interlocks are designed to resist high tensile loads, but the section has very little beam strength, i.e., section modulus. When properly interlocked, this three-point contact interlock system can withstand severe setting and driving conditions and still function as intended. Gerdau PS sections provide the highest swing to interlock strength ratios available. This enables a wide range of project designs, from small radii connecting arcs to very large diameter cells.



Tensile Diagram For Properly Interlocked PS Sections

PS and Z-Piling sections should not be interlocked together. Gerdau PS 27.5 and PS 31 can be interlocked with each other. Interlocking of Gerdau PS section with another producer’s section should never be considered unless approved in advance by Gerdau Ameristeel.

CELLULAR CONSTRUCTION UTILIZING PS SHEET PILING

A cellular structure may be as simple as a single independent circular cell, or it could be a series of connected cells. A closed cell must be constructed using an even number of sections, including connectors.

HOW A CELL FUNCTIONS:

Cellular design requires that the cells be founded on or in firm foundation material – and that the cells be filled with clean, free-draining granular material. The granular fill forces the sheets outward and places the cell wall into tension in the horizontal direction. The tension exerted on the wall is resisted by the high interlock strength of the PS sections.

A cell is normally designed to resist horizontal forces. In general it can be stated that the ability of a cell to resist horizontal forces increases as its diameter and height increases, usually in a one-to-one ratio. On the other hand, as the diameter and cell height increases, the required interlock strength of the PS sections also increases. Normal engineering practice is to limit the interlock load of PS sections to one-half the minimum ultimate interlock strength.

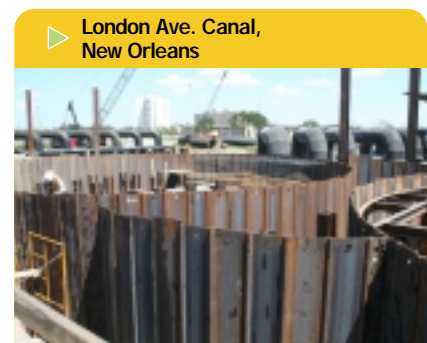

GERDAU SHEET PILING

TWO TYPES OF CELLULAR CONSTRUCTION:

CLOSED CELLS:

Single Cell Structures: Typically used in bridge abutments, shallow water docks, and mooring dolphins for securing barges. Cells are used to protect bridge piers from barge or ship impacts.

Continuous Closed Structures: Series of cells joined together with connecting arcs. Two types follow:

PERMANENT STRUCTURES

- Deep Draft Bulkheads
- Graving Docks for construction of ships in the dry
- Flood control structures

TEMPORARY STRUCTURES

- Environmental remediation
- Cofferdams used in construction of locks and dams
- Repair of canal walls
- Construction of Hydroelectric facilities

OPEN CELLS:

The Open Cell® design is used primarily for docks and similar structures. Each cell's sheet pilings are driven in an arc, when viewed from above, with a vertical flat sheet pile membrane extending shoreward. The Open Cell® bulkhead has several unique features:

- Does not need excessive toe embedment for stability, therefore requiring less driving time
- Significant time and financial savings utilizing this design versus traditional bulkhead designs
- The highest vertical load carrying capacity dock in the world
- Not settlement sensitive

The design was developed and proven by PND Engineers, Inc. for extreme seismic and climate conditions in Alaska. It is a proven design that has withstood high ice loading, large tide changes and corrosion factors. More than 170 projects have been installed.

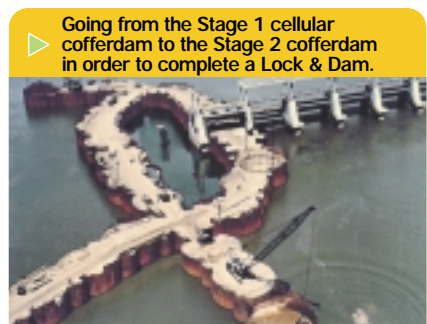

More information on Open Cell Design can be found at www.pnd-anc.com or www.opencell.us

Cellular construction yields the following benefits:

- Provides a massive, self-sustaining structure that is safe and durable.
- Provides the highest load capacity structure.
- Can be installed by the average-size marine contractor without the need for unusually large equipment.
- Eliminates the need for construction and maintenance of slope protection and other disadvantages of open piling supported platforms because cells provide a solid-faced wharf.
- Eliminates many of the details of expensive and structurally vulnerable anchorage systems required for high-modulus, tied-back anchored walls.
- Provides long service life in marine environments, especially when augmented by modern corrosion protection methods.

▶ Closed Cells,
Port of San Diego, California



▶ Open Cell Dock,
Seward, Alaska



▶ Open Cell Design



GERDAU SHEET PILING

PS (FLAT SHEET) PILING PROPERTIES

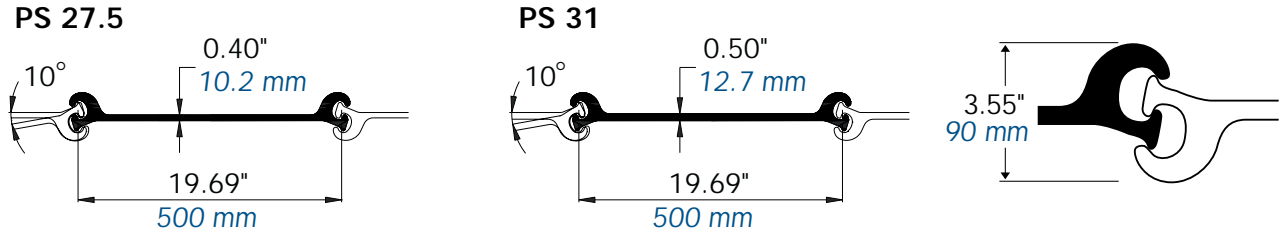

Section	Per Single Section										Per Unit of Wall			
	Nominal Width in. (mm)	Depth (Height) in. (mm)	Wall Depth (Height) in. (mm)	Web Thickness in. (mm)	Area in. ² (cm ²)	Weight lbs/ft (kg/m)	Moment of Inertia in. ⁴ (cm ⁴)	Section Modulus in. ³ (cm ³)	Total Surface Area ft ² /ft (m ² /m)	Nominal Coating Area* ft ² /ft (m ² /m)	Area in. ² /ft (cm ² /m)	Weight lbs/ft ² (kg/m ²)	Moment of Inertia in. ⁴ /ft (cm ⁴ /m)	Section Modulus in. ³ /ft (cm ³ /m)
PS 27.5	19.69	2.83	3.55	0.40	13.26	45.1	5.0	3.2	4.50	3.64	8.08	27.5	3.0	1.9
	500	72	90	10.2	85.5	67.1	207	52	1.37	1.11	171.0	134.2	414	103
PS 31	19.69	2.83	3.55	0.50	14.96	50.9	5.0	3.2	4.50	3.64	9.11	31.0	3.0	1.9
	500	72	90	12.7	96.5	75.7	207	52	1.37	1.11	192.9	151.4	414	103

*Both sides of sheet: excludes interior of interlock.

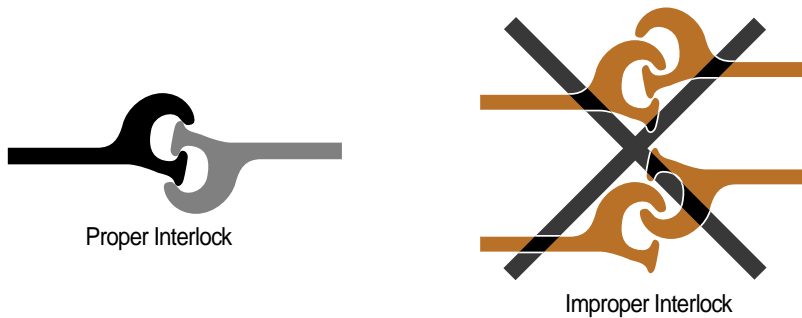

Grade	Minimum Interlock Strength ⁽¹⁾	Minimum Swing ⁽²⁾
A328	16 kips/in. (2,800 kN/m)	10 degrees
A572-50	20 kips/in. (3,500 kN/m)	10 degrees
A572-60	24 kips/in. (4,200 kN/m)	10 degrees

Higher interlock strengths are available but obtainable swing may be reduced in interlock strengths above 24 kips/in (4,200 kN/m).

- (1) These minimum ultimate interlock strengths assume proper interlocking of sheets. To verify the strength of PS Sheet Piling, both yielding of the web and failure of the interlock should be considered.
- (2) Swing reduces 1.5 degrees for each 10 feet (3 meters) in length over 70 feet (21 meters).

NOTE: INTERLOCKING OF GERDAU PS SECTIONS WITH ANOTHER PRODUCER'S SECTION SHOULD NEVER BE CONSIDERED UNLESS APPROVED IN ADVANCE BY GERDAU AMERISTEEL. PS and Z-Piling sections should not be interlocked together. Gerdau PS 27.5 and PS 31 can be interlocked with each other.

CONNECTORS FOR PS SHEET PILING

Extruded or hot-rolled connectors are suggested for Wye and Tee connections between cells. Consistent quality control during manufacturing, combined with ease of use and efficiency of construction, make these engineered products superior to traditional fabricated sections.

Advantages of connectors are:

- Eliminates welded connections.
- Faster product delivery – no delays waiting for fabricated sections.
- Easily transported, handled, stored and installed.
- SWC 120 and weld-on connectors are stocked with sheet piling.
- Swing or rotation is equal to the Gerdau PS Sheet Piling interlock.

Please go to pages 22 and 23 of this handbook to view PS layouts using the SWC connectors. Visit www.sheet-piling.com for orientation of connectors in cellular layouts.

WELD-ON CONNECTOR

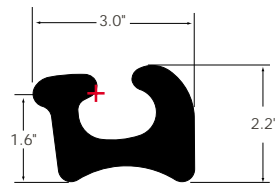

SWC 120 120° Wye

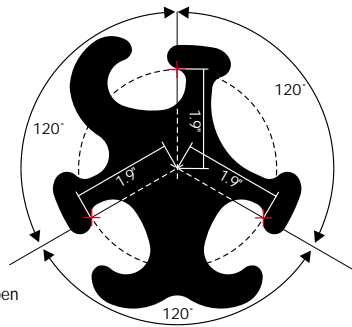

Wye Connector for Open Cell construction.

SWC 30 A 30° Wye

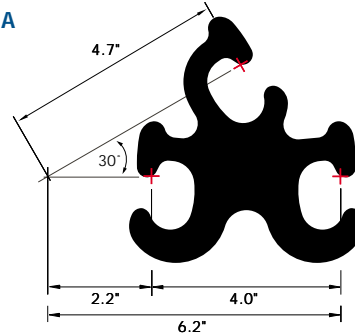

SWC 30 B 30° Wye

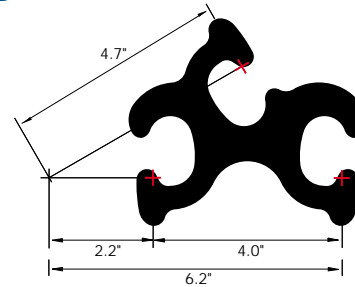

SWC 90 A 90° Tee

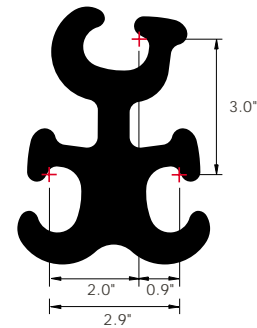

SWC 90 B 90° Tee

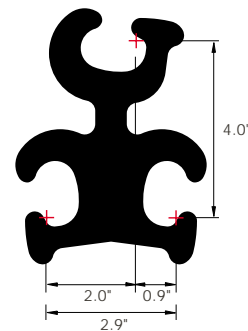

Please note that SWC 60A and SWC 60B are also available.

PS FLAT SHEET PILING 90° EXTRUDED TEE LAYOUT

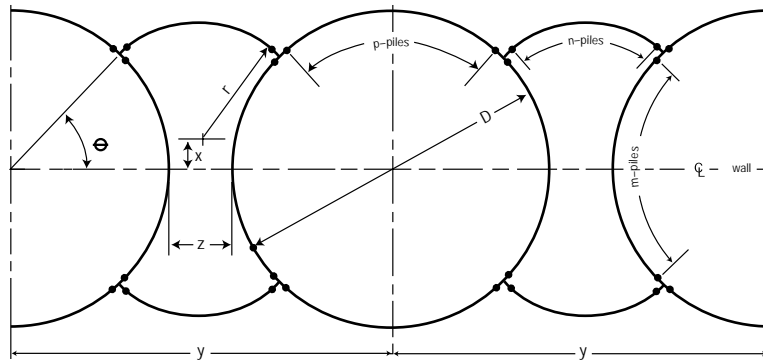

⊖ measured to the center of the 90° connection

Number of Piles in Cell†	D ft (m)	z ft (m)	y ft (m)	r ft (m)	X ft (m)	⊖ deg	Number of Piles			Area		Average Width ft (m)	Layout Number (see Website)
							m	n	p	Within Circle sq ft (sq m)	Between Circles sq ft (sq m)		
44	21.20	7.53	28.73	9.72	0.68	45.3	10	9	10	353	197	19.2	4
	6.46	2.30	8.76	2.96	0.21					32.8	18.3	5.9	
48	23.29	6.84	30.13	9.67	1.45	45.2	11	9	11	426	203	20.9	6
	7.10	2.08	9.18	2.95	0.44					39.6	18.9	6.4	
52	25.38	6.31	31.69	9.73	2.15	45.2	12	9	12	506	210	22.6	4
	7.74	1.92	9.66	2.97	0.66					47.0	19.5	6.9	
56	27.47	5.62	33.09	9.68	2.92	45.2	13	9	13	593	213	24.3	6
	8.37	1.71	10.09	2.95	0.89					55.1	19.8	7.4	
60	29.56	5.09	34.64	9.73	3.62	45.2	14	9	14	686	218	26.1	4
	9.01	1.55	10.56	2.97	1.10					63.7	20.3	8.0	
64	31.65	5.95	37.60	10.76	3.58	45	15	10	15	787	264	27.9	3
	9.65	1.81	11.46	3.28	1.09					73.1	24.5	8.5	
68	33.73	5.42	39.15	10.82	4.28	45	16	10	16	894	269	29.7	5
	10.28	1.65	11.93	3.30	1.30					83.1	25.0	9.1	
72	35.82	4.73	40.55	10.76	5.05	45.2	17	10	17	1008	269	31.5	3
	10.92	1.44	12.36	3.28	1.54					93.6	25.0	9.6	
76	37.91	5.59	43.51	11.83	5.09	45.1	18	11	18	1129	324	33.4	4
	11.55	1.70	13.26	3.61	1.55					104.9	30.1	10.2	
80	40.00	4.91	44.91	11.77	5.87	45.1	19	11	19	1257	323	35.2	6
	12.19	1.50	13.69	3.59	1.79					116.8	30.0	10.7	
84	42.09	5.92	48.02	12.91	5.76	45	20	12	20	1391	386	37.0	5
	12.83	1.80	14.64	3.93	1.76					129.2	35.9	11.3	
88	44.18	5.24	49.42	12.85	6.53	45	21	12	21	1533	384	38.8	3
	13.47	1.60	15.06	3.92	1.99					142.4	35.7	11.8	
92	46.27	6.10	52.37	13.92	6.57	45.1	22	13	22	1681	450	40.7	4
	14.10	1.86	15.96	4.24	2.00					156.2	41.8	12.4	
96	48.36	5.42	53.77	13.86	7.34	45.1	23	13	23	1837	448	42.5	6
	14.74	1.65	16.39	4.22	2.24					170.7	41.6	13.0	
100	50.45	4.88	55.33	13.92	8.04	45.1	24	13	24	1999	451	44.3	4
	15.38	1.49	16.86	4.24	2.45					185.7	41.9	13.5	
104	52.54	5.74	58.28	14.94	8.01	45	25	14	25	2168	445	46.1	3
	16.01	1.75	17.76	4.55	2.44					201.4	41.3	14.1	
108	54.63	6.61	61.24	16.01	8.05	45.1	26	15	26	2344	596	48.0	4
	16.65	2.01	18.67	4.88	2.45					217.8	55.4	14.6	
112	56.72	5.92	62.64	15.95	8.82	45.1	27	15	27	2526	592	49.8	6
	17.29	1.80	19.09	4.86	2.69					234.7	55.0	15.2	
116	58.80	5.39	64.19	16.01	9.52	45.1	28	15	28	2716	595	51.6	4
	17.92	1.64	19.57	4.88	2.90					252.3	55.3	15.7	
120	60.89	6.25	67.14	17.03	9.49	45	29	16	29	2912	674	53.4	3
	18.56	1.91	20.46	5.19	2.89					270.5	62.6	16.3	
124	62.98	5.71	68.7	17.08	10.19	45	30	16	30	3116	677	55.2	5
	19.20	1.74	20.94	5.21	3.11					289.5	62.9	16.8	
128	65.07	5.03	70.1	17.03	10.96	45	31	16	31	3326	670	57.0	3
	19.83	1.53	21.37	5.19	3.34					309.0	62.2	17.4	

Layout drawings showing the orientation of the extruded connections can be found at www.sheet-piling.com.

†Includes 4 extruded 90° Tee connectors

PS FLAT SHEET PILING 90° EXTRUDED TEE LAYOUT

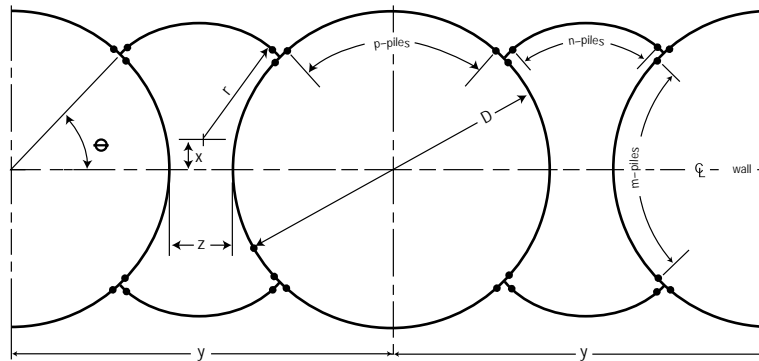

⊖ measured to the center of the 90° connection

Number of Piles in Cell†	D ft (m)	z ft (m)	y ft (m)	r ft (m)	X ft (m)	θ deg	Number of Piles			Area		Average Width ft (m)	Layout Number (see Website)
							m	n	p	Within Circle sq ft (sq m)	Between Circles sq ft (sq m)		
44	21.20	7.53	28.73	9.72	0.68	45.3	10	9	10	353	197	19.2	4
	6.46	2.30	8.76	2.96	0.21					32.8	18.3	5.9	
48	23.29	6.84	30.13	9.67	1.45	45.2	11	9	11	426	203	20.9	6
	7.10	2.08	9.18	2.95	0.44					39.6	18.9	6.4	
52	25.38	6.31	31.69	9.73	2.15	45.2	12	9	12	506	210	22.6	4
	7.74	1.92	9.66	2.97	0.66					47.0	19.5	6.9	
56	27.47	5.62	33.09	9.68	2.92	45.2	13	9	13	593	213	24.3	6
	8.37	1.71	10.09	2.95	0.89					55.1	19.8	7.4	
60	29.56	5.09	34.64	9.73	3.62	45.2	14	9	14	686	218	26.1	4
	9.01	1.55	10.56	2.97	1.10					63.7	20.3	8.0	
64	31.65	5.95	37.60	10.76	3.58	45	15	10	15	787	264	27.9	3
	9.65	1.81	11.46	3.28	1.09					73.1	24.5	8.5	
68	33.73	5.42	39.15	10.82	4.28	45	16	10	16	894	269	29.7	5
	10.28	1.65	11.93	3.30	1.30					83.1	25.0	9.1	
72	35.82	4.73	40.55	10.76	5.05	45.2	17	10	17	1008	269	31.5	3
	10.92	1.44	12.36	3.28	1.54					93.6	25.0	9.6	
76	37.91	5.59	43.51	11.83	5.09	45.1	18	11	18	1129	324	33.4	4
	11.55	1.70	13.26	3.61	1.55					104.9	30.1	10.2	
80	40.00	4.91	44.91	11.77	5.87	45.1	19	11	19	1257	323	35.2	6
	12.19	1.50	13.69	3.59	1.79					116.8	30.0	10.7	
84	42.09	5.92	48.02	12.91	5.76	45	20	12	20	1391	386	37.0	5
	12.83	1.80	14.64	3.93	1.76					129.2	35.9	11.3	
88	44.18	5.24	49.42	12.85	6.53	45	21	12	21	1533	384	38.8	3
	13.47	1.60	15.06	3.92	1.99					142.4	35.7	11.8	
92	46.27	6.10	52.37	13.92	6.57	45.1	22	13	22	1681	450	40.7	4
	14.10	1.86	15.96	4.24	2.00					156.2	41.8	12.4	
96	48.36	5.42	53.77	13.86	7.34	45.1	23	13	23	1837	448	42.5	6
	14.74	1.65	16.39	4.22	2.24					170.7	41.6	13.0	
100	50.45	4.88	55.33	13.92	8.04	45.1	24	13	24	1999	451	44.3	4
	15.38	1.49	16.86	4.24	2.45					185.7	41.9	13.5	
104	52.54	5.74	58.28	14.94	8.01	45	25	14	25	2168	445	46.1	3
	16.01	1.75	17.76	4.55	2.44					201.4	41.3	14.1	
108	54.63	6.61	61.24	16.01	8.05	45.1	26	15	26	2344	596	48.0	4
	16.65	2.01	18.67	4.88	2.45					217.8	55.4	14.6	
112	56.72	5.92	62.64	15.95	8.82	45.1	27	15	27	2526	592	49.8	6
	17.29	1.80	19.09	4.86	2.69					234.7	55.0	15.2	
116	58.80	5.39	64.19	16.01	9.52	45.1	28	15	28	2716	595	51.6	4
	17.92	1.64	19.57	4.88	2.90					252.3	55.3	15.7	
120	60.89	6.25	67.14	17.03	9.49	45	29	16	29	2912	674	53.4	3
	18.56	1.91	20.46	5.19	2.89					270.5	62.6	16.3	
124	62.98	5.71	68.7	17.08	10.19	45	30	16	30	3116	677	55.2	5
	19.20	1.74	20.94	5.21	3.11					289.5	62.9	16.8	
128	65.07	5.03	70.1	17.03	10.96	45	31	16	31	3326	670	57.0	3
	19.83	1.53	21.37	5.19	3.34					309.0	62.2	17.4	

Layout drawings showing the orientation of the extruded connections can be found at www.sheet-piling.com.

†Includes 4 extruded 90° Tee connectors

GERDAU SHEET PILING

DIAMETERS AND AREAS OF CIRCULAR CELLS USING PS 27.5 AND PS 31

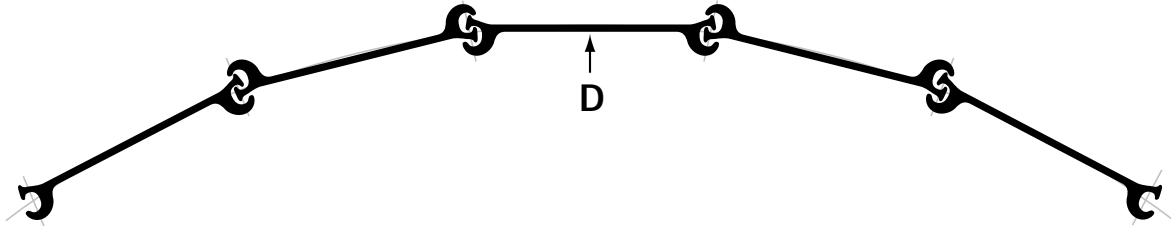

Number of Pieces	PS 27.5 & PS 31		Required Swing degrees	Theoretical Bend degrees \ominus	Suggested Bend degrees \ominus
	D ft	Area ft ²			
12	6.27	31	30.0	20.0	25.0
14	7.31	42	25.7	15.7	25.0
16	8.36	55	22.5	12.5	20.0
18	9.40	69	20.0	10.0	15.0
20	10.45	86	18.0	8.0	15.0
22	11.49	104	16.4	6.4	15.0
24	12.53	123	15.0	5.0	10.0
26	13.58	145	13.8	3.6	10.0
28	14.62	168	12.9	2.9	10.0
30	15.67	193	12.0	2.0	10.0
32	16.71	219	11.3	1.3	10.0
34	17.76	248	10.6	0.6	10.0
36	18.80	278	10.0		
38	19.85	309	9.5		
40	20.89	343	9.0		
42	21.94	378	8.6		
44	22.98	415	8.2		
46	24.03	453	7.8		
48	25.07	494	7.5		
50	26.11	536	7.2		
52	27.16	579	6.9		
54	28.20	625	6.7		
56	29.25	672	6.4		
58	30.29	721	6.2		
60	31.34	771	6.0		
62	32.38	824	5.8		
64	33.43	878	5.6		
66	34.47	933	5.5		
68	35.52	999	5.3		
70	36.56	1050	5.1		
72	37.61	1111	5.0		
74	38.65	1173	4.9		
76	39.69	1238	4.7		
78	40.74	1304	4.6		
80	41.78	1371	4.5		
82	42.83	1441	4.4		
84	43.87	1512	4.3		
86	44.92	1585	4.2		
88	45.96	1659	4.1		
90	47.01	1736	4.0		
92	48.05	1813	3.9		
94	49.10	1893	3.8		
96	50.14	1975	3.8		
98	51.18	2057	3.7		
100	52.23		21433.6		

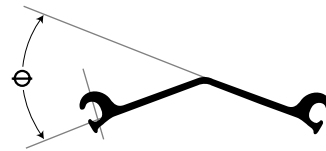

Small cells constructed with bent web piles must have half of the piles bent with the fingers inside and half with the fingers outside.

PS 27.5 and PS 31 when properly interlocked, are designed to provide a swing up to 10 degrees (in either direction) for lengths up to 70 feet (21 meters). The ability to obtain a full 10 degrees swing decreases with length because of the difficulty in handling the longer pieces. For lengths over 70 feet (21 meters), it is necessary to anticipate a reduction in obtainable swing of 1.5 degrees for each 10 feet (3 meters) increase in length.

Setting and Driving Tips for PS Flat Sheets:

Although setting and driving techniques vary with the individual contractor and site conditions, several basic principles can generally be applied. It should be realized that the lack of good setting and driving practices can result in job delays and an unsatisfactory structure. The following suggestions are offered to help avoid problems at the site:

Handling of PS sections: These sections have very little modulus (beam strength) and are, therefore, very susceptible to handling damage. It is important that great care be taken when transporting or lifting these sections. When sheets exceed 70 feet (21 meters) in length, they should be lifted at two or more points. See page 33 for more information on transport, storage, and handling of sections

Have an adequate steel template: Longer sheeting lengths will require a two or three tier template with tiers spaced 15 feet (4.5 meters) or more apart. For example, a contractor should consider at least a two tier template when installing 70 foot (21 meters) or longer sheets as this will facilitate setting and driving and result in a superior end product. As with Z-Piling, it is important that each sheet be plumbed and secured when set.

The diameter of the template is predicated on the contractor's experience and method of setting circular cells. It is important that the template diameter be less than the theoretical inside clear cell diameter in order to easily close the cell. Wood blocking may be utilized to adjust the template to ensure the proper setting width. Upon filling, the finished cell will expand to meet or exceed published values.

When a cell with long lengths is being constructed, it may be advisable to stiffen the starter sheet by reinforcing it full length with a structural shape. Site conditions such as swift water or hard driving may require more sheets to be reinforced.

Splicing: When it is necessary to splice PS sections the splice point on adjacent sheets should be staggered by several feet.

Mark the driving template for each pile or pair of piles: This allows for wall adjustments to be made during the setting phase, insuring that the sheets are located properly for cell closure.

Ensure that the sheets are properly interlocked when set: Improper interlocks become the "weak links" and result in job delays and/or failures. Refer to page 20 for definition of a proper interlock. A closed cell must have an even number of sections (including connectors) to avoid an improper interlock.

Set all sheets in the cell before driving any of the sheets, other than nominal pinning of the starter sheet(s).

"Shake out" several sheets at any closure point: Following good practice as noted above should ideally result in the last sheet sliding smoothly down into the remaining gap. Although the first sheet is set plumb and the next to last sheet is plumb, the chances that the remaining gap is uniform (19.69 inches or 500 mm) the full length is improbable. Picking up and dropping, or "shaking out," several sheets near the closure point until the sheets run smoothly will minimize the chance of driving sheets out of interlock.

Drive piles in pairs: Once sheet piles are threaded and set, it is more economical to drive two at a time. Some experts suggest that the energy needed to drive a pair may be only 50% more than that required to drive a single pile.

Drive piles in stages and work around the entire cell by alternating sheets (pairs): This allows the piles to be guided by those previously driven, and lessens the chance of driving sheets out of interlock. The distance a pile, or pair of piles, should be driven at any one time will be governed by the driving conditions. In the first pass around the cell, every other pair is driven perhaps 4 feet (1.2 meters). In the second pass around the cell, the un-driven pairs are driven 8 feet (2.4 meters), 4 feet (1.2 meters) restrained by the adjacent pairs and then 4 feet (1.2 meters) into virgin soil. This procedure is continued until the cell is driven to design tip elevation. Good practice, in order to keep the cell plumb, is to reverse the direction of driving for each pass around the cell.

GERDAU SHEET PILING

CORROSION

INTRODUCTION

It is not uncommon for an engineer designing a steel sheet piling structure to have concerns about corrosion. The following discussion will give some guidance in assessing possible corrosion potential in various environments including: fresh water, soil, and salt water. There is also discussion on available protective measures when corrosion protection must be employed.

DURABILITY OF STEEL PILES IN VARIOUS ENVIRONMENTS

IN UNPOLLUTED FRESH WATER: There is very little published data regarding the corrosion of steel piling in unpolluted fresh water. This lack of data is explained by the general absence of significant corrosion of steel piling structures located in fresh water. Two examples of sheet piling structures with long life are located in New York:

- A bulkhead at Black Rock in Buffalo, NY. This dock was constructed in 1910
- A bulkhead near Albany, NY which was constructed in 1929.

IN SOIL: In 1959 the National Bureau of Standards (NBS)* initiated a research program to investigate the corrosion of steel piling driven into soil. This effort was under the direction of Melvin Romanoff, a longtime corrosion researcher who was well known for his research in pipeline corrosion.

In 1962, Melvin Romanoff authored NBS Monograph 58, entitled "Corrosion of Steel Piling in Soils." The following excerpts are taken from his summary.

"Steel pilings which have been in service in various underground structures for periods ranging between 7 and 40 years were inspected by pulling piles at 8 locations and making excavations to expose pile sections at 11 locations. The conditions at the sites varied widely, as indicated by the soil types which ranged from well-drained sands to impervious clays, soil resistivities which ranged from 300 ohm-cm to 50,200 ohm-cm and soil pH which ranged from 2.3 to 8.6."

"The data indicate that the type and amount of corrosion observed on the steel pilings driven into undisturbed natural soils, regardless of the soil characteristics and properties, is not sufficient to significantly affect the strength or useful life of pilings as load-bearing structures."

"...The data indicate that undisturbed soils are so deficient in oxygen at levels a few feet (1 meter) below the ground line or below the water table zone, that steel pilings are not appreciably affected by corrosion, regardless of the soil types or the soil properties. Properties of soils such as type, drainage, resistivity, pH or chemical composition are of no practical value in determining the corrosiveness of soils toward steel pilings driven underground. This is contrary to everything previously published pertaining to the behavior of steel under disturbed soil conditions. Hence, it can be concluded that National Bureau of Standards data previously published on specimens exposed in disturbed soils do not apply to steel pilings which are driven in undisturbed soils."

*Now named the National Institute of Standards and Technology (NIST)

Romanoff continued his research through the 60's. In 1969 he presented a paper at the 25th Conference of the National Association of Corrosion Engineers (NACE). This paper was based on corrosion data from 25 piles with exposures from 8 to 50 years in a wider variety of soil environments and different geographic locations than those covered in Monograph 58.

In this second report Romanoff concluded:

"The observations reported in this paper are in agreement and substantiate the observations and conclusions based on the results of the previous examinations on steel pile structures which are published in NBS Monograph 58."

Mr. Romanoff initiated research on corrosion of steel piling driven into disturbed soils in 1966. This research resulted in NBS Monograph 128, entitled "Corrosion Rates on Underground Steel Test Piles at Turcot Yard, Montreal," which he co-authored with W.J. Schwerdtfeger. In recent years, research on corrosion of steel piling driven into disturbed soils and "dirty" fills has been sponsored by the National Cooperative Highway Research Program (NCHRP).

Additional information on these subjects can be found at the NACE website at www.NACE.org.

IN A MARINE ENVIRONMENT: The use of steel piles in marine environments is common, and the questions of corrosion and appropriate methods of protection merit serious consideration. The life of unprotected steel piling in sea-water installations varies with the conditions of exposure.

Structures located in protected harbors can be expected to have a considerably longer life than shore structures which are subject to salt spray, wave action, and sand abrasion.

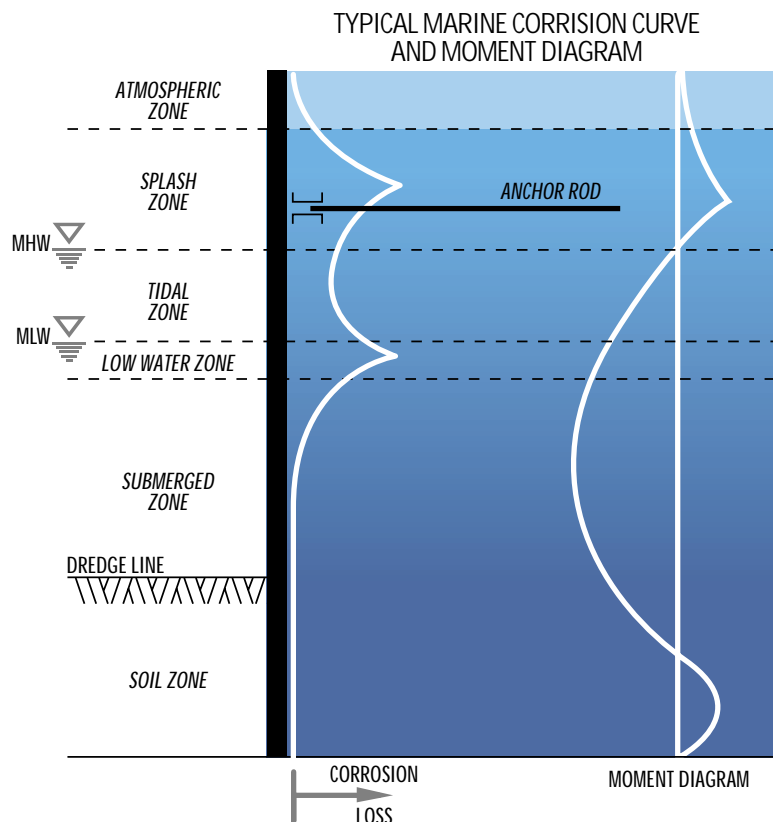

The above curves are generalized and can vary depending on many factors.

GERDAU SHEET PILING

(Corrosion continued)

The most severe corrosion occurs in the **splash zone**. In this zone, rust films have little opportunity to become dry and, therefore, do not develop protective properties. Corrosion in this area is further aggravated by oxygen in the air and the fact that the splashing sea water has high oxygen content. Corrosion rates increase with increasing oxygen concentrations. If the water is shallow and the structure is subjected to breaking waves, the removal of corrosion products by sand particles in the water may accelerate the corrosion rate.

In the **tidal zone**, the corrosion may be minimal. The corrosion may increase from mean low tide down one or two feet (0.3 or 0.6 meters) into the **submerged zone**, or the **low-water zone**.

The rate of corrosion decreases rapidly with water depth and is comparatively low at depths greater than two feet (0.6 meters) below mean low water (MLW). In some cases, there is an increase at the dredge line, not usually serious. If the structure is located in a shallow tidal estuary, the movement of sand at the dredge line may continually blast-clean the steel at that point. Protective measures, such as cathodic protection, must be taken to control the corrosion/erosion effects encountered in such locations.

PROTECTING AGAINST CORROSION

PROTECTIVE COATINGS

The most common method of protecting steel piling against corrosion is through the use of coatings, such as a coal tar epoxy system. It is important when coating steel that the steel surface be grit blasted to near white or white as specified by the paint manufacturer. A common coating system is 16 mils of coal tar epoxy. For additional coating life, a designer might consider an organic zinc rich primer.

To be effective, a coating must cover the splash zone, the tidal zone, and extend several feet below low water. Generally the coating is extended to a depth five feet (1.5 meters) below mean low water. Below that point, the steel is completely submerged and the oxygen content greatly lowered. Therefore, corrosion will usually proceed at a much reduced rate. The decision of whether to extend the coating through the submerged zone to a few feet (1 meter) below the dredge line usually depends upon the design life of the structure. For economy and quality control, the coatings should be applied in a shop by an experienced applicator.

For best long term durability and appearance of the sheet piling sections at the interlocked joint, it is recommended the sheets be coated as single pieces, rather than pairs. By coating single sections, a better coated system will be obtained in the joint area.

THICKER STEEL:

It is sometimes suggested in the literature that the solution to corrosion is the use of thicker steel.

From the above discussion it should be understood that the most severe corrosion occurs in a relatively small zone of the piling which is usually not highly stressed (the area is lightly loaded). Using thicker steel to protect a relatively short length of the piling results in an increased total piling weight which escalates costs. It makes better economical sense to protect the critical corrosion zone with a good coating system applied to a properly prepared steel surface.

CONCRETE JACKETING:

Concrete jacketing of steel piling has been used and can be very effective. In shallow water, complete encasement of the submerged portion will offer excellent protection. Designers should exercise caution, however, when designing partial jackets because a corrosion cell may form at the steel concrete interface. This could result in an increased rate of corrosion on the unencased, bare steel adjacent to the concrete jacket. To prevent or minimize the formation of such a cell, the designer should insulate the steel from the concrete. This may be accomplished by the application of a coating extending approximately one foot (0.3 meters) each side of the interface. Dense concrete should be used, and any steel reinforcement should have a minimum cover of 4 inches (10 centimeters).

CATHODIC PROTECTION:

An effective method of corrosion control for continually submerged steel is cathodic protection. Unprotected steel in sea water corrodes by an electrochemical process. Sea water having a low electrical resistance functions as the electrolyte. Certain areas of the steel are anodic and current flows from them through the sea water to cathodic areas. The circuit is completed through the metal. Corrosion occurs only at the anodic areas and, if the flow of current is prevented, corrosion cannot occur.

Simply put, cathodic protection is a corrosion control method which makes the steel pile the cathode of an external electrochemical cell. Sufficient current is applied to the steel pile from an external source to eliminate anodic areas on the steel. The direct current source can be either a rectifier or sacrificial anodes suspended in the water.

A properly designed, installed, and maintained cathodic protection system effectively prevents corrosion in the submerged zone. It is, however, only partially effective in the tidal zone and provides no protection in the splash zone. Therefore, a cathodically protected structure would have to be protected in the tidal and splash zones by some other method such as a coating system. Normally the submerged zone is coated since this will reduce the power requirements for the system.

Since the corrosion rate of steel decreases rapidly with depth below MLW, the need for cathodic protection is often uncertain in the design stage. Therefore, it is good practice to connect the piles electrically during construction. Then, if the need for the system is determined by later inspection of the structure, it can be installed conveniently.

Additional information on these subjects can be found at the NACE website at www.NACE.org.

GERDAU SHEET PILING

(Corrosion continued)

ALTERNATE STEEL GRADES:

Gerdau Steel piling products are also available in ASTM A690.

ASTM A690 is a High-Strength Low-Alloy Steel which contains Nickel, Copper and Phosphorus at considerably higher levels than typical carbon structural steel. It exhibits increased corrosion resistance to salt water corrosion in the splash zone of exposed marine structures as compared to typical carbon structural steels*. No other corrosion benefit claims are made for A690.

Based on corrosion studies, A690, as well as other corrosion resisting steels, behave in a manner similar to carbon structural steels with respect to corrosion when submerged in water or driven in soil. A690 will not provide any benefit in the Low Water Zone, which will likely be the location of the highest bending moment. Since A690 has no effect in the area that may be the most critical from a moment perspective, it will not extend the life of the steel sheet piling structure.

Due to the harshness of a marine environment, A690 steel will not provide aesthetics. As mentioned above, it will provide increased corrosion resistance only in the splash zone, and it will corrode. Manufacturing A690 requires additional alloys that are costly.

Therefore, specifying A690 to protect a relatively small splash zone area significantly increases the cost of the wall and is not a cost effective solution.

**The greater splash zone corrosion resistance of A690 in salt water was based on comparison testing performed in the 50's and 60's with carbon steels made from virgin ores. However, due to the residual elements found in today's scrap based steel production of A328 and A572, the degree of improvement for A690 splash zone corrosion resistance is likely not as great as the values obtained in the tests using virgin ore based steels. Testing performed in China during the 1990's comparing the anti-corrosion effect of different alloying elements in low alloy steel compositions showed that higher levels of Phosphorus and Copper had an evident effect in the splash zone.*

SPECIFICATIONS

Gerdau Steel Grades for PZC, PZ, and PS Profiles

North American Grades		
ASTM	Yield Strength	
	(ksi)	(MPa)
A 328	39	270
A 572 Grade 50	50	345
A 572 Grade 60	60	415
A 572 Grade 65	65	450
A 690*	50	345

European Grades		
EN 10248	Yield Strength	
	(ksi)	(MPa)
S 240 GP	35	240
S 270 GP	39	270
S 355 GP	51	355
S 430 GP	62	430
S 450 GP	65	450

*A690 contains specified levels of Ni, Cu, and P at higher levels than the other listed grades on the table.

A572 Grade 50 and S 355 GP are the most economical and readily available grades. Inquire for minimum order requirements for other grades.

S 240 GP, S 270 GP, and S 355 GP Z-profiles can be supplied for European projects requiring the ÜHP proof of conformity.

Gerdau Sheet Piling Grades and their Chemistries

	ASTM A328	ASTM A572-50	ASTM A572-60	ASTM A572-65	ASTM A690
C %	**	0.23 max	0.26 max	0.23 max	0.22 max
Mn %	**	1.35 maxA	1.35 maxA	1.65 maxB	0.60 - 0.90C
P %	0.035 max	0.04 max	0.04 max	0.04 max	0.08 - 0.15
S %	0.04 max	0.05 max	0.05 max	0.05 max	0.04 max
Si %	**	0.40 max	0.40 max	0.40 max	0.40 max
Cu %	**	**	**	**	0.50 min
Ni %	**	**	**	**	0.40 - 0.75
Cr %	**	**	**	**	**
Mo %	**	**	**	**	**
Sn %	**	**	**	**	**
V %	**	0.010 - 0.15*	0.010 - 0.15*	0.010 - 0.15*	**
Cb / Nb %	**	0.005 - 0.05*	0.005 - 0.05*	0.005 - 0.05*	**
Yield ksi [MPa]	39 min [270]	50 min [345]	60 min [415]	65 min [450]	50 min [345]
Tensile ksi [MPa]	65 min [450]	65 min [450]	75 min [520]	80 min [550]	70 min [485]
Elong %	17 @ 8 in.	18 @ 8 in.	16 @ 8 in.	15 @ 8 in.	18 @ 8 in.

*would contain singly or in combination, dependent on production type (1, 2 or 3)

** = not specified (Where ** is shown for copper a minimum of 0.20 may be specified).

(A) For each reduction of 0.01% below C maximum, an increase of 0.06% Mn above specified maximum is permitted, up to a maximum of 1.50%.

(B) For material with thickness of 1/2" (13mm) or less, Mn maximum of 1.35% would apply when C is greater than 0.21%.

(C) For each reduction of 0.01% below C maximum, an increase of 0.06% Mn above specified maximum is permitted, up to a maximum of 1.10%.

GERDAU SHEET PILING

MECHANICAL TESTING

Tensile tests are performed in accordance with the stated requirements of the applicable ASTM or EU standard material specification, which reference testing specification detail.

In addition to the standard tensile test, a minimum of two interlock strength tests are performed for each heat of PS sections.

TOLERANCES

When using steel sheet piling it is necessary to make allowances for deviations from theoretical exactness. The basic character of the rolling processes and normal limitations of mill equipment limit the degree of precision obtainable in the production of steel sheet piling. Therefore, care must be taken during installation to assure that each pair of sheets is being set at the desired driving dimensions.

Interlocks should be continuous, reasonably free-sliding to grade when threaded, and for PS sections should have sufficient clearance to allow piles to be swung within the stated limits.

All steel sheet piling has an allowable weight variation of $\pm 2.5\%$ and are invoiced on theoretical weight. Length tolerance is minus 0 inches (0 millimeters) and plus 5 inches (127 millimeters).

LENGTHS

Sheet piling sections are rolled and cut to ordered length. For best economy, the designer should specify the actual length as calculated in the design process. Stock lengths are typically available in 5 feet (1.5 meters) increments.

All sections are readily available in lengths up to 70 feet (21 meters) from regular rollings. Gerdau can supply longer lengths, sometimes in excess of 100 feet (30 meters). Before ordering lengths exceeding 70 feet (21 meters) check for availability.

SPLICING

If possible, splicing of Z-piling sections should be avoided. If splicing is necessary, sections should be ordered full length from the mill. They should be match-marked and cut at the jobsite. These match-marked sections should then be spliced together. This procedure improves section geometry match-up. Splicing of random sheets could result in setting and driving difficulties.

Please refer to page 16 for additional splicing comments on Z-Piling and page 25 for PS piling.

HANDLING HOLES

Z-PILING: Paired sections will have one handling hole in both sections, with both holes at the same end of the pair.

PS-PILING: Each piece will be provided with one handling hole at one end.

SWING

The ability to obtain swing (rotation) between two properly interlocked sections will decrease with increasing length. This is due to the fact that as the length becomes longer, and handling becomes more difficult, straightness becomes more of a factor.

Z-PILING: Gerdau does not publish a swing value for Z-sections. As a “rule of thumb” it might be assumed that a 40 foot (12 meters) length would obtain a swing of up to 5 degrees.

PS-PILING: The Gerdau PS sections with interlock strengths up to 24 kips per inch (4,200 kN/m) are designed to have a minimum swing of 10 degrees in either direction on lengths up to 70 feet (21 meters). With longer lengths it is necessary to anticipate a reduction in obtainable swing of 1.5 degrees for each 10 feet (3 meters) in length over 70 feet (21 meters)

TRANSPORT, STORAGE, AND HANDLING

When storing or transporting PS Sections or unpaired Z-piling, dunnage should be identically sized, evenly spaced, and placed perpendicular to the longitudinal direction of the material. Each piece of dunnage should have at least a 4 inch (102 millimeters) width contacting the material in order to prevent damage due to point loading. Spacing between dunnage should not exceed 15 feet (4.6 meters), with both ends supported no more than 4 feet (1.2 meters) from either end. Ground or base dunnage should be placed on the same stacking pattern. When stacking bundles higher than one layer, dunnage on each layer should be placed directly above the dunnage below. Caution should be exercised when stacking multiple layers so as to not exceed the capacity of the dunnage being used, or adversely affect the stability of the stack.

When storing or transporting paired Z-piling, placement of ground or base dunnage shall be as described above. If intermediate blocking is needed between pairs, as would be expected to protect applied coating, those pieces should be identically sized and placed on each free flange as well as on both sides of the interlock at the joined section. If intermediate blocking is necessary between single Z-piling or PS Sections, it should be identically sized and placed on the flanges.

The intermediate blocking should be placed directly above the ground or base dunnage. If using chain or wire sling devices to handle material, the material should be protected from the sling to prevent damage to the section.

GERDAU SHEET PILING

300 Ward Road
Midlothian, TX 76065
USA

972.775.8241
800.527.7979

www.sheet-piling.com

©2008 Gerdau Ameristeel

PZC Sheet Piling covered by Patents 7,360,969; 7,168,891; and 7,018,140

PZC™ is a registered trademark of Gerdau Ameristeel